

SMOOTH FIBERGLASS, TEXTURED FIBERGLASS & STEEL ENTRY DOORS

CODEL
ENTRY SYSTEMS™

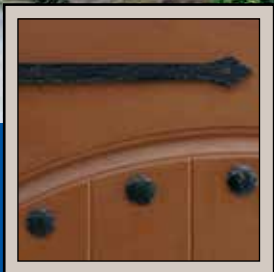

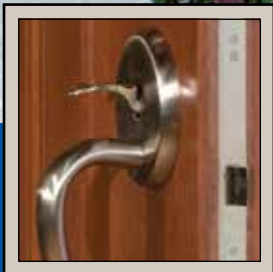
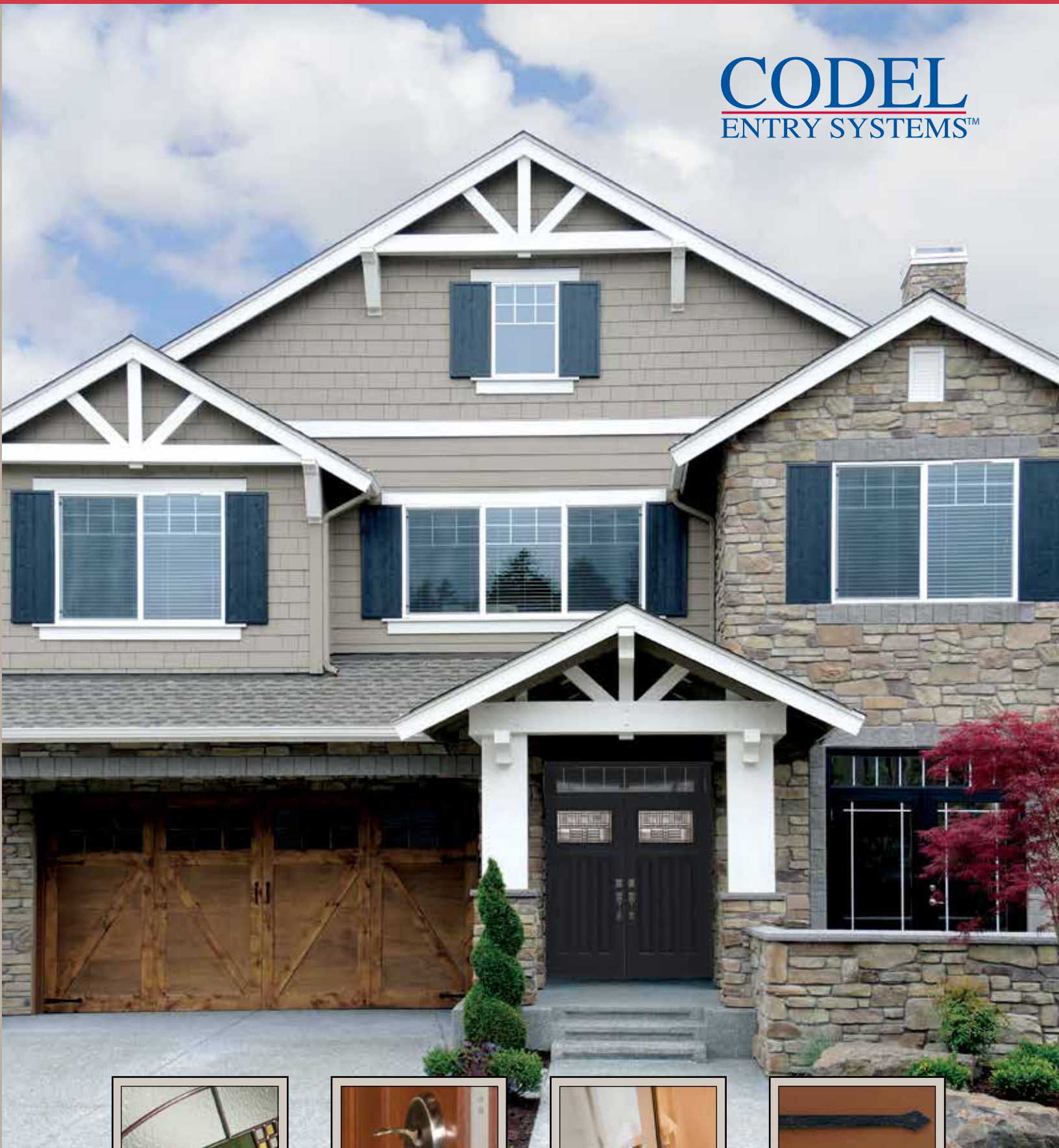

Complete & On-time DELIVERY!
Featuring Smooth Fiberglass, Textured Fiberglass & Steel Entry Systems.

Table of Contents

Codel Distinct Features.....	4
Codel Difference & Testing Results.....	5
Smooth Fiberglass Standard Door Collection.....	6-8
Textured Fiberglass Standard Door Collection.....	9-10
SF & TF Flush-Glazed Fiberglass Doors	11
Fir Grain TF Belleville Standard Collection	12
SF & TF Contemporary Classics Collection.....	13
SF & TF EZ-Fit “Retro Sized” Swinging Patio Doors.....	14
SF & TF New Construction Swinging Patio Doors.....	15
SF & TF EZ-Fit “Retro Sized” Double Doors.....	16
Obscure Glass Options	17
Steel Standard Door Collection	18-19
90-Minute Fire Doors.....	20-21
Decorative Collection.....	22-63
6/8 Standard Craftsman Collection	64-65
6/8 Belleville Craftsman Collection	66-67
6/8 Fir-Grain Flush-Glazed Craftsman Collection	68-69
6/8 SF Flush-Glazed Craftsman Collection	70
6/8 Flush-Glazed “Barrington” Craftsman Collection	71
8/0 SF Flush-Glazed Craftsman Collection	72-73
Rustic Collection	74-75
Multi-Point.....	76-77
Retractable Screen	78
Raise & Lower Mini Blinds.....	79
DoorGuard / JambGuard / SillGuard / Hinge Options.....	80
Sills & Astragals.....	81
WeatherGuard	82
Codel Coatings	83
Installation Recommendations.....	84
Finishing Recommendations	85
The “Codel Way”	86
Net Unit Measurements	87
Transom Sizes, Door Handing & Door Skin Textures	88
Index	89-91

Smooth Fiberglass WAT-480 doors.



Codel Fiberglass Doors Distinct Features

The Fiberglass door from Codel is virtually maintenance free and offers a limited lifetime warranty. Unlike other brands of fiberglass doors that offer only wood edges, the Codel Fiberglass door is manufactured with composite edges as well as composite top and bottom rails, leaving no exposed wood. The Codel fiberglass door has a clean appearance, with radius mortised hinge preps instead of swiping completely through the door edge. With the harsh Pacific Northwest climate, we believe this all-composite Fiberglass door will give years of satisfaction.



Attractive Flush Glazing
Creates a crisp, contemporary appearance. (Optional)
Lite plugs installed in standard lite kit frames.
(*Lite kit shown not flush glazed.)

JambGuard™
Heavy duty steel reinforcement plate for added protection and security.
(*Not on sidelite or double units.)

Premium High Dam Sill
Provides an improved barrier against air and water intrusion.



Seams-Rite™ Nailing Flange
Seams-Rite™ is an innovative hidden fastener eliminating unsightly nail holes and provides a barrier to water intrusion.
(Standard on WeatherGuard Jamb only)

The nailing flange allows the door to be installed without damaging finished jamb facings.
(Optional)



Finishing Touch
Enhance the beauty and value of your door with any of our quality coatings, for a completely finished & ready-to-install door system. (Optional)

Cougar paint

LIMITED LIFE TIME WARRANTY

Unfinished Smooth Fiberglass



WeatherGuard™
A unique low maintenance poly-fiber doorframe system that outlasts wood jambs. Does not wick moisture, splinter or rot. (Optional)



LVL Stile
Continuous 3-1/4" lock block extending the full length of the lock-side, keeping the door from bowing and improves security.



Corner Seal
Added protection against water and air infiltration.



High Performance Sweep
Provides a tight seal against drafts.



High Density Polyurethane Foam
Provides 5 times the insulation value of wood doors.



HydroShield™ Technology
Composite framework seals out moisture and eliminates rot and deterioration.

What's Inside DOES Make A Difference

CODEL ENTRY SYSTEMS Fiberglass Door



FEATURES	BENEFITS	CODEL ENTRY SYSTEMS	Others
1 Hydroshield Technology Composite Edge Perimeter (No Exposed Wood)	Seals out moisture, greatly reducing its damaging effects such as rotting, bowing and delamination, providing a <i>longer lasting</i> and <i>better performing</i> door over the years.	✓	N/A
2 Heavy Duty Full Length Lock Block (LVL) Laminated Veneer Lumber	Greater <i>strength</i> and <i>stability</i> built into the latch side of the door for sturdy support for hardware and other security features, as well as improved resistance to bowing.	✓	N/A
No Paint Required Limited Lifetime Warranty	Because Codel fiberglass doors are designed with <i>Hydroshield Technology</i> , doors are not finished, but painting is not required to maintain the warranty.	✓	N/A
3 Polyurethane Foam Core (100% CFC Free)	Provides greater insulation and energy efficiency than wood doors.	✓	✓
4 Fiberglass Skin	Fiberglass skins won't rot like wood doors or dent like steel doors.	✓	✓

*The information noted represents the majority of the doors we offer, however, there are some exceptions.

Thermal Performance values established in accordance with ETC Laboratories (NFRC) Simulation Report

	R value	U value	SHGC value
Fiberglass Full Panel door unit w/no glass	6.25	0.16	0.00
Fiberglass door unit w/1/4 Clear Glass	4.35	0.23	0.10
Fiberglass door unit w/1/2 Clear Glass	3.57	0.28	0.19
Fiberglass door unit w/Full Clear Glass	2.70	0.37	0.33
Fiberglass door unit w/1/2 Mini Blind	3.57	0.28	0.22
Fiberglass door unit w/Full Mini Blind	2.70	0.37	0.30
Fiberglass door unit w/1/2 LowE Glass	4.17	0.24	0.16
Fiberglass door unit w/Full LowE Glass	3.45	0.29	0.28
Fiberglass door unit w/1/2 LowE Mini Blind	4.00	0.25	0.15
Fiberglass door unit w/Full LowE Mini Blind	3.33	0.30	0.26
Fiberglass door unit w/1/4 Decorative Glass	4.76	0.21	0.09
Fiberglass door unit w/1/2 Decorative Glass	4.16	0.24	0.17
Fiberglass door unit w/3/4 Decorative Glass	3.85	0.26	0.26
Fiberglass door unit w/Full Decorative Glass	3.23	0.31	0.30
Fiberglass door unit w/Flush Glazed Clear Glass	2.56	0.39	0.42
Fiberglass door unit w/Flush Glazed LowE Glass	3.70	0.27	0.32

TESTING RESULTS BY INDEPENDENT LABS

- ASTM D-1761 - Screw holding Capacity Test: Minimum Load: 450 lbs. Timberline CE Load: 867 lbs.
- ASTM F-1450 - Door Static Load Test Sec. 7.3: Minimum Load: 1,000 lbs. Timberline CE Load: 2,169 lbs.
- ASTM D-1666 - Machining Test: The Timberline CE met requirements for sawing, planing, routing, boring, drilling and chisel.
- ASTM E-283 - Air Infiltration: Test Pressure: 1.57 psf (25 mph) Timberline CE Results: 0.10 scmf/ft.
- ASTM E-331 - Water Resistance: Test Pressure: 2.86 psf (25 mph) Timberline CE Results: Passed, no leakage past innermost.
- ASTM E-330 - Uniform Structural Load: Test Pressure: 50.0 psf (positive) Timberline CE Results: Pass, no failure.
- STC Rating - Rating=29 (Full panel door unit w/no glass.) 27 (Flush Glazed Full Lite)

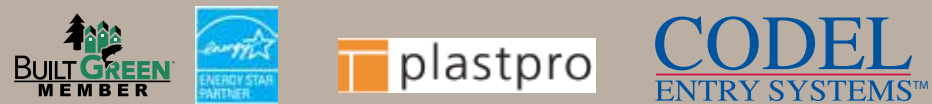

Smooth Fiberglass Collection



8/0 SF6P door.

Key Code Chart

GBG Available w/Grids between Glass

LE Available w/Low-E Glass

● Available in 7⁰ Height

▲ Available in 8⁰ Height

■ Extended Leadtime Required

◆ Available w/Panic Blocking/
Closure Reinforcement (6-8 Only)

🔥 20-Min. Fire Rated (6-8 Only)

<p>SF6P/SF6P20</p> <p>▲26 ●28 ◆30</p> <p>*20-Minute Option Available in 2-8 & 3-0 (6/8)</p>	<p>SFF</p> <p>20 24 ●26 ●28 210 ●30 36</p>	<p>SF4P/SF4P20</p> <p>28 ▲30</p> <p>*20-Minute Option Available in 2-8 & 3-0 (6/8)</p>	<p>SF44</p> <p>28 30</p>	<p>SF2P</p> <p>28 ▲30</p>	<p>SF2PC</p> <p>28 30</p>	<p>SF3P</p> <p>▲30</p> <p>8/0 Has Curved Top Panel</p>	<p>SF66</p> <p>30</p>
<p>SF9P</p> <p>28 30</p>	<p>SF93</p> <p>30</p>	<p>SF62</p> <p>●28 210 ◆30</p>	<p>SF64</p> <p>●28 210 ◆30</p> <p>Fixed Grid Only</p>	<p>SF64C</p> <p>◆▲30</p> <p>Clear Glass</p>	<p>SF64GBG</p> <p>◆▲30</p> <p>GBG only</p>	<p>SFC</p> <p>28 210 ◆30</p>	<p>SFW</p> <p>28 210 ◆30</p> <p>Fixed Grids Standard</p>
<p>SF622</p> <p>26 ●28 210 ◆30</p> <p>LE 6-8, 7-0 / ■ LE 8-0</p>	<p>SF61</p> <p>26 ●28 210 ◆30</p> <p>LE 6-8, 7-0 / ■ LE 8-0</p>	<p>SF29</p> <p>■26 ●28 210 ◆30</p> <p>GBG Only</p>	<p>SF69</p> <p>26 ●28 210 ◆30</p> <p>Fixed Grid Standard</p>	<p>SF6V</p> <p>26 ●28 210 ◆30</p> <p>Vented Glass w/screen</p>	<p>SF81</p> <p>28 ▲30</p> <p>■ LE 6-8 / LE 8-0</p>	<p>SF611P</p> <p>28 ▲30</p> <p>LE 6-8 / ■ LE 8-0</p>	<p>SF291P</p> <p>28 30</p> <p>■ LE</p>
<p>SF691P</p> <p>28 30</p> <p>Fixed Grids Standard</p>	<p>SF6V1P</p> <p>28 30</p> <p>Vented Glass w/screen</p>	<p>SF611PC</p> <p>28 30</p> <p>LE</p>	<p>SF291PC</p> <p>28 30</p> <p>GBG Only</p>	<p>SF691PC</p> <p>28 30</p> <p>Fixed Grids Standard</p>	<p>SF6V1PC</p> <p>28 30</p> <p>Vented Glass w/screen</p>	<p>SF1</p> <p>●26 ●28 210 ◆30 36</p> <p>LE 6-8, 7-0 / ■ LE 8-0</p>	<p>SF919CL</p> <p>●28 210 ◆30 36</p> <p>Clear Glass</p>

We Finish What We Start!



Color samples are reproduced as close as possible, actual color may vary.

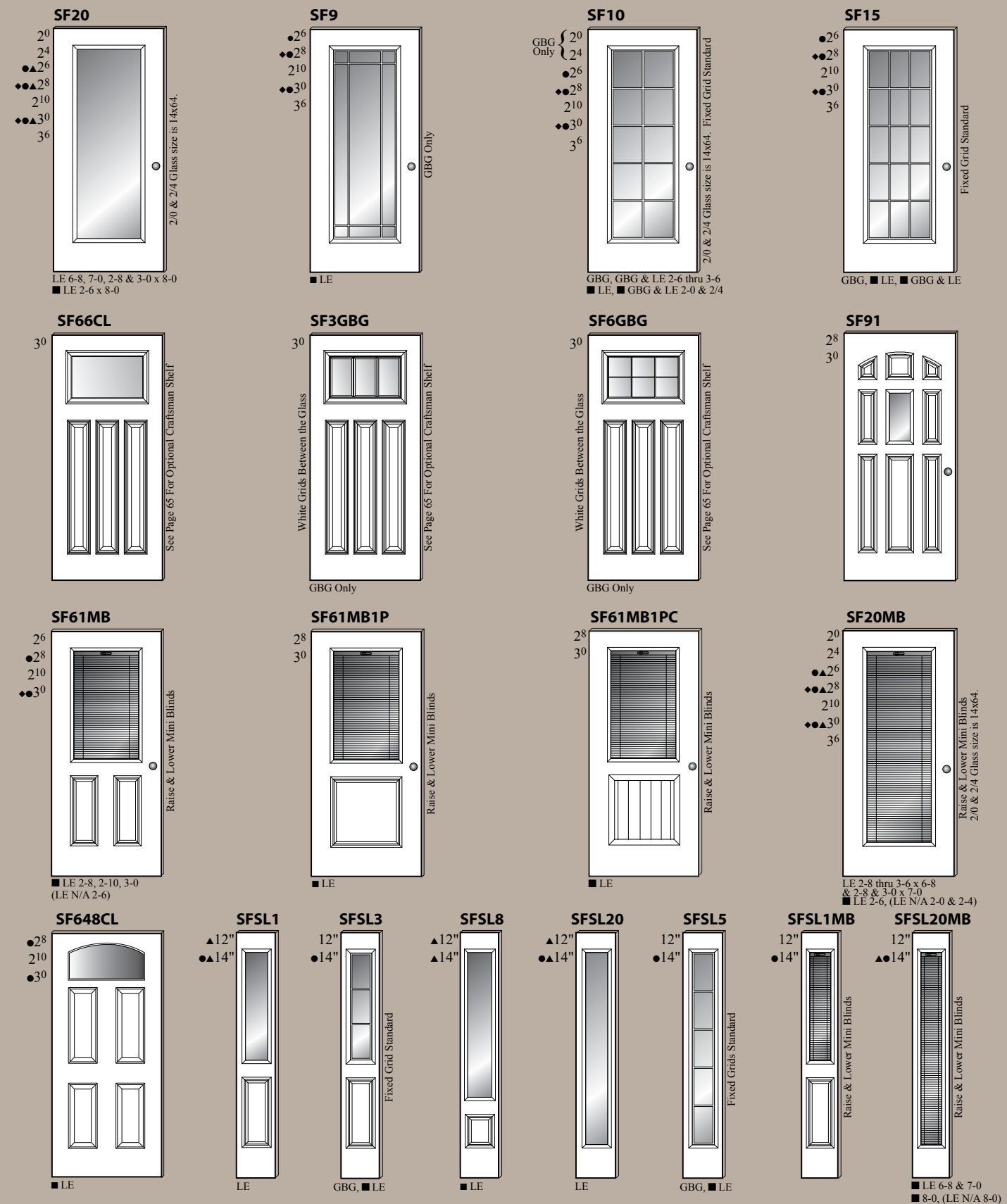

Color samples are reproduced as close as possible, actual color may vary.

CODEL ENTRY SYSTEMS™

Textured Fiberglass Collection



TF66CL door with C-21 craftsman shelf.

Key Code Chart

GBG Available w/Grds Between Glass

LE Available w/Low-E Glass

▲ Available in 8⁰ Height

■ Available w/Extended Leadtime.

🔥 20-Min. Fire Rated (6-8 Only)

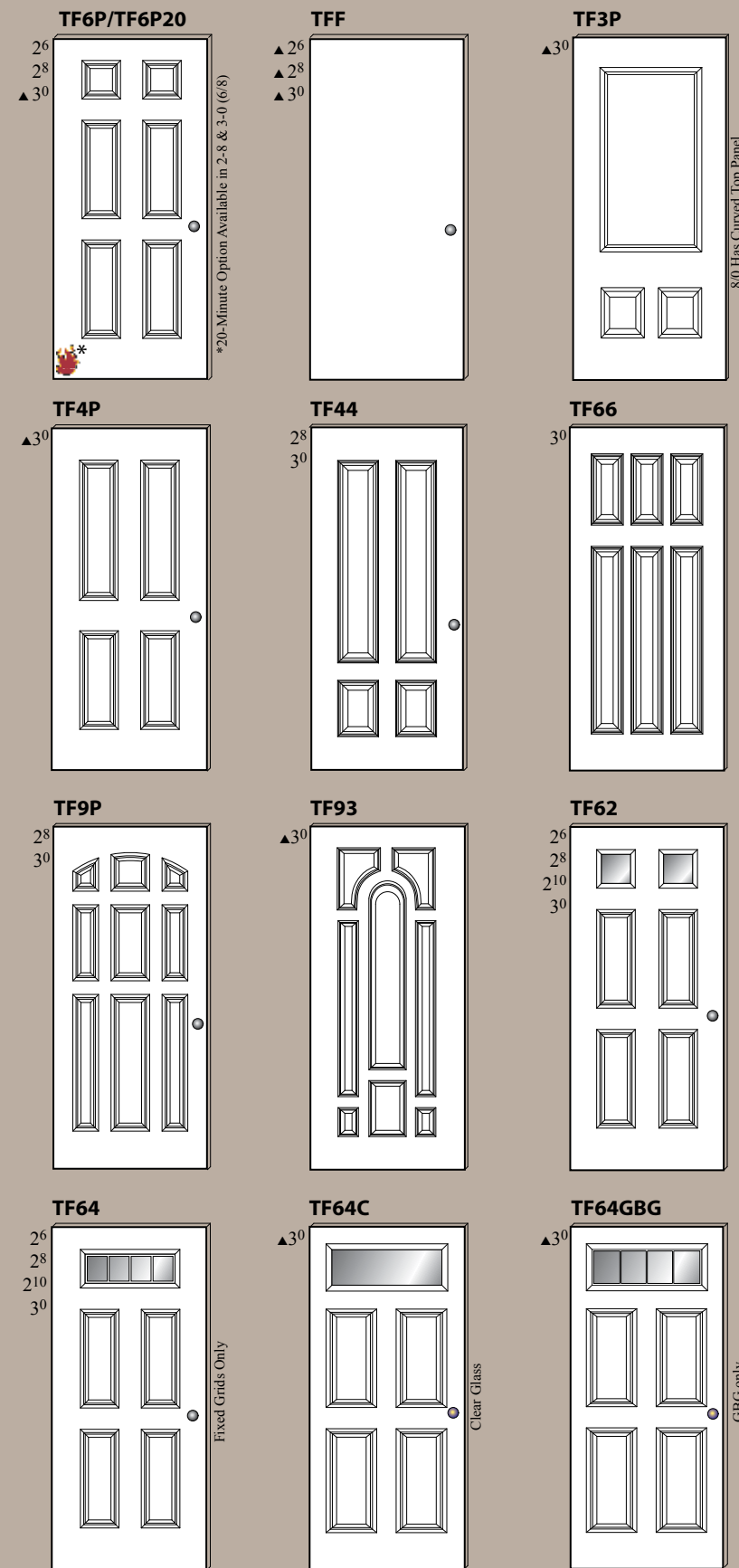

Color samples are reproduced as close as possible, actual color may vary.



Color samples are reproduced as close as possible, actual color may vary.

CODEL ENTRY SYSTEMS™

Smooth & Textured Fiberglass Flush-Glazed Fiberglass Doors



8/0 SF20F Flush-Glazed door.

Key Code Chart

GBG Available w/Grids Between Glass

LE Available w/Low-E Glass

■ Available w/Extended Leadtime.

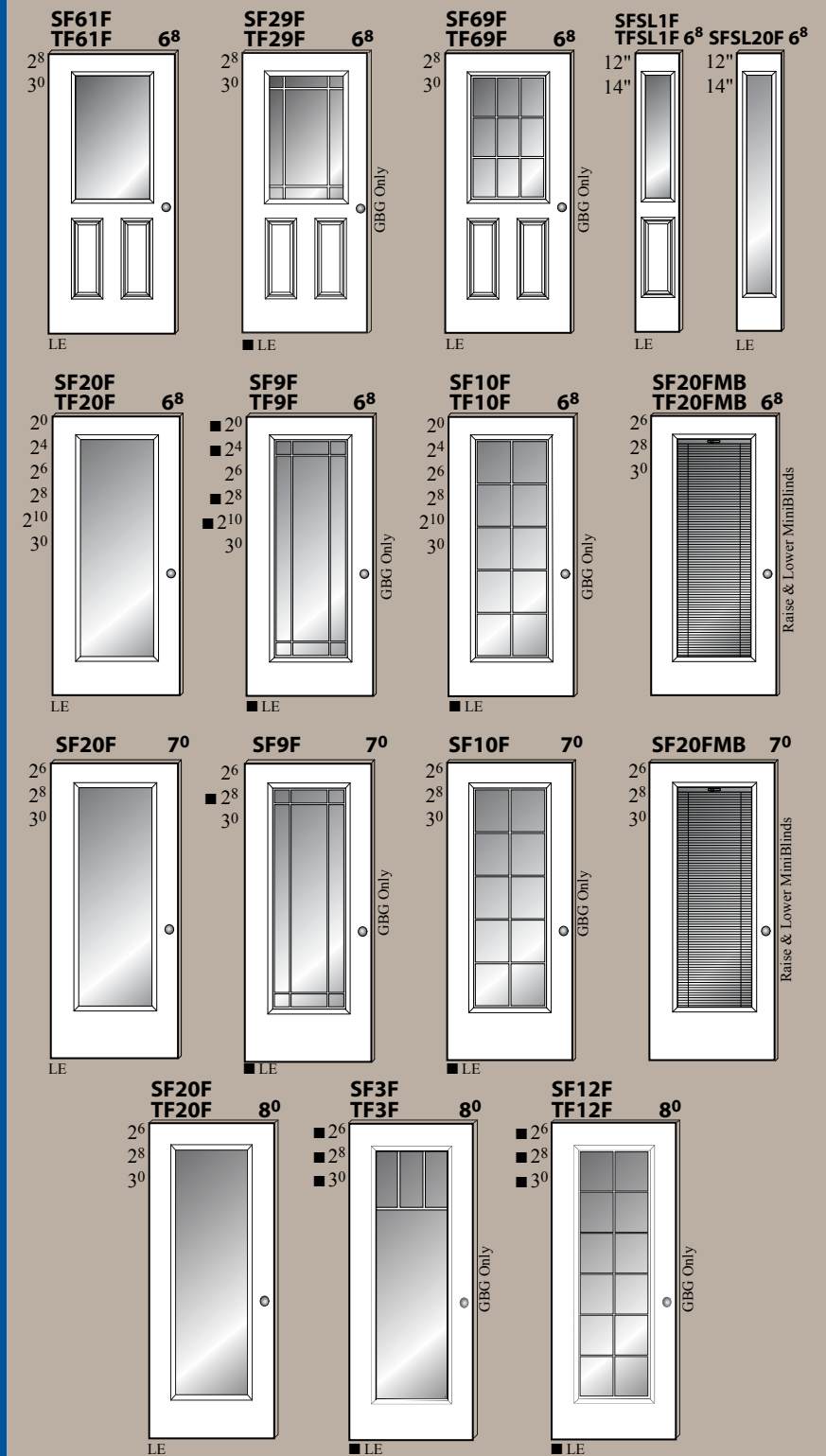

Flush-Glazed Profile vs. Standard Lite Kit Profile



Fir Grain Textured Fiberglass
Belleville Collection



FG6P

Key Code Chart

GBG Available in Grids between Glass

LE Available in Low-E Glass

■ Extended Leadtime Required

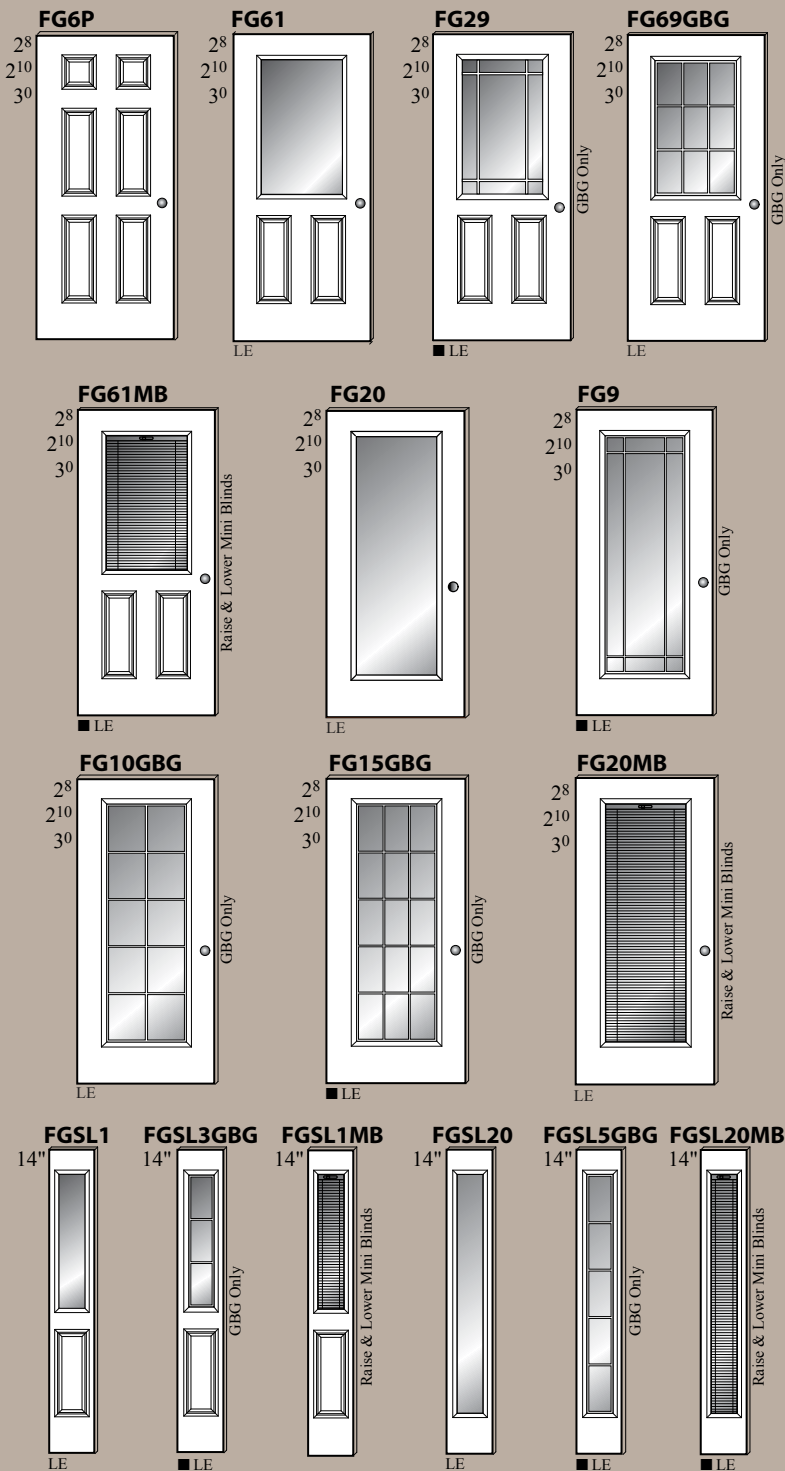

**Choose One of 3 Factory-Applied Stains
Specially Formulated For These
Fir-Grain Doors & Sidelites.**

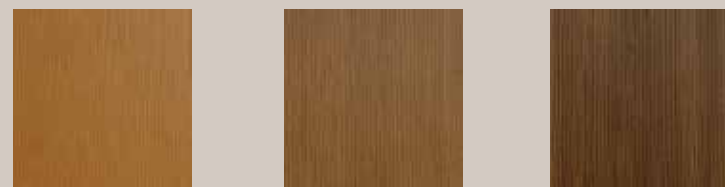

Ginger Nutmeg Clove

Color samples are reproduced as close as possible, actual color may vary.

Smooth & Textured Fiberglass
Contemporary Classics Collection



CON-15153 W/Rain Glass.

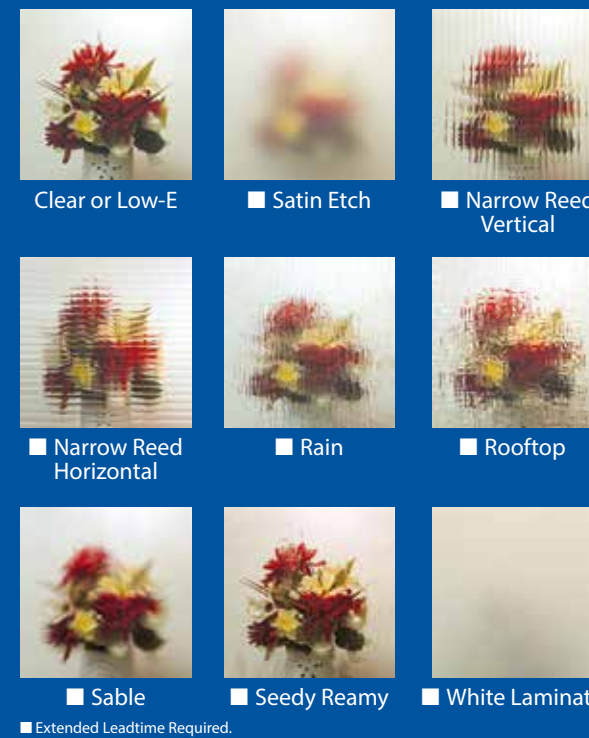

■ Extended Leadtime Required.

Contemporary Classics

Blending contemporary glass options with classic door designs was the inspiration for our new “Contemporary Classics Collection”. Available in either smooth or textured fiberglass, in a wide variety of door styles and glass options, be inspired! You choose the door style, you choose the glass. The choice is yours!

(Contemporary Classics Available in 3-0 x 6/8)



■ Extended Leadtime Required.
Color samples are reproduced as close as possible, actual color may vary.

CODEL ENTRY SYSTEMS™

Smooth & Textured Fiberglass EZ-Fit "Retro Sized" Swinging Patio

Codel's EZ-Fit swinging Patio System is a retro-sized unit created as a replacement for that worn out aluminum sliding door, which makes it ideal for remodel projects. Available as either an inswing or outswing unit, the hinged operation eliminates security and performance problems often experienced with traditional sliding patio doors.

Codel's EZ-Fit swinging Patio System is manufactured completely prehung, with an installed retractable screen, in your color choice of either white or bronze.

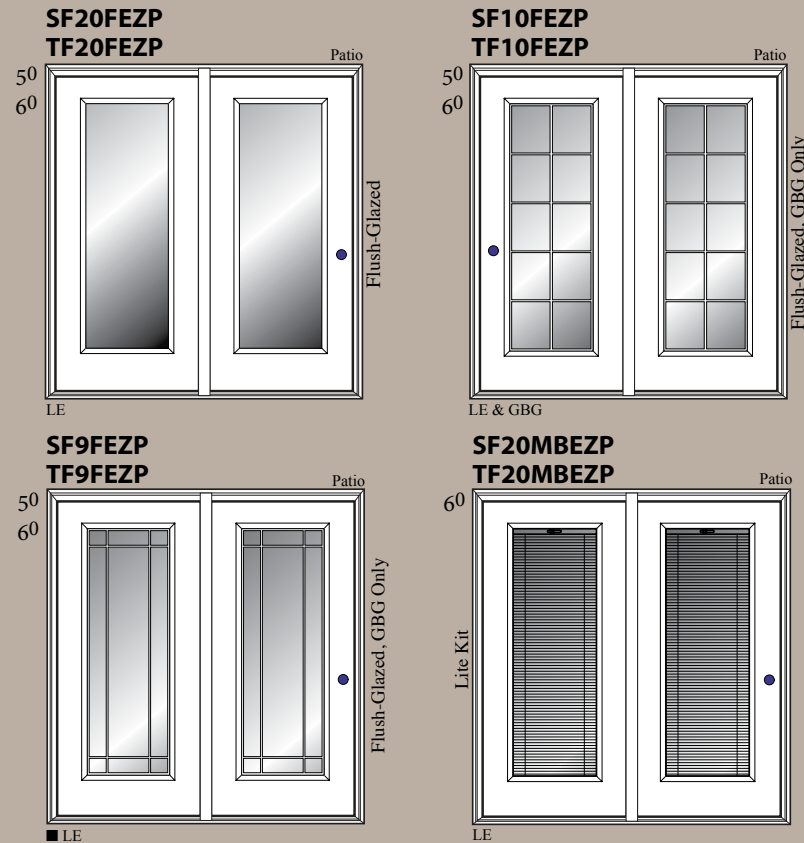

Net UNIT Heights

Door Width	Net UNIT Width	Adjustable Inswing Sill	Bumper Outswing Sill
5'0" Patio	59-1/4"	79-1/2"	78-1/4"
6'0" Patio	71-1/4"	79-1/2"	78-1/4"



Smooth Fiberglass SF20FEZP patio with the Codel retractable screen. See page 78 for more information on our retractable screen.

PATIO HANDING

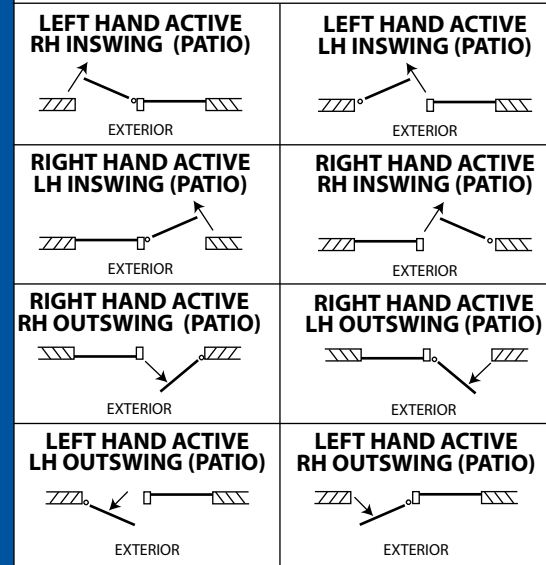

Key Code Chart

- LE Available w/Low-E Glass
- Available w/extended Leadtime.

CODEL ENTRY SYSTEMS™

Smooth & Textured Fiberglass New Construction Swinging Patio

Codel's New Construction swinging Patio System is an attractive alternative to wood or vinyl sliding patio doors.

Available as either an inswing or outswing unit, the hinged operation eliminates security and performance problems often experienced with traditional sliding patio doors.

Codel's New Construction swinging Patio System is manufactured completely prehung, with an installed retractable screen, in your choice of either white or bronze.



Smooth Fiberglass SF9FNCP patio door.

PATIO HANDING

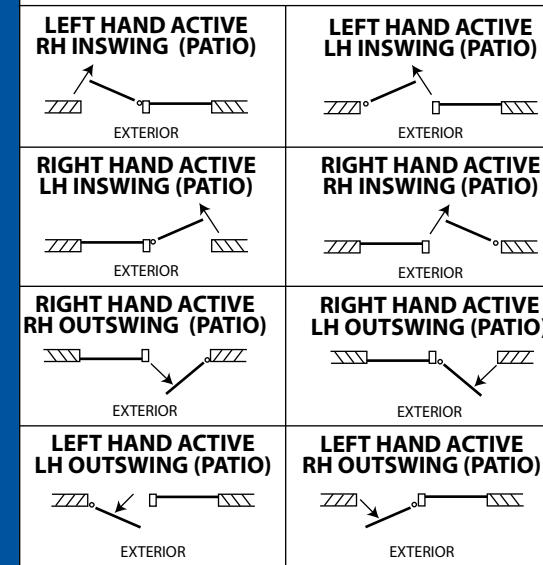

Key Code Chart

- LE Available w/Low-E Glass
- Available w/extended Leadtime.
- F Available Flush Glazed

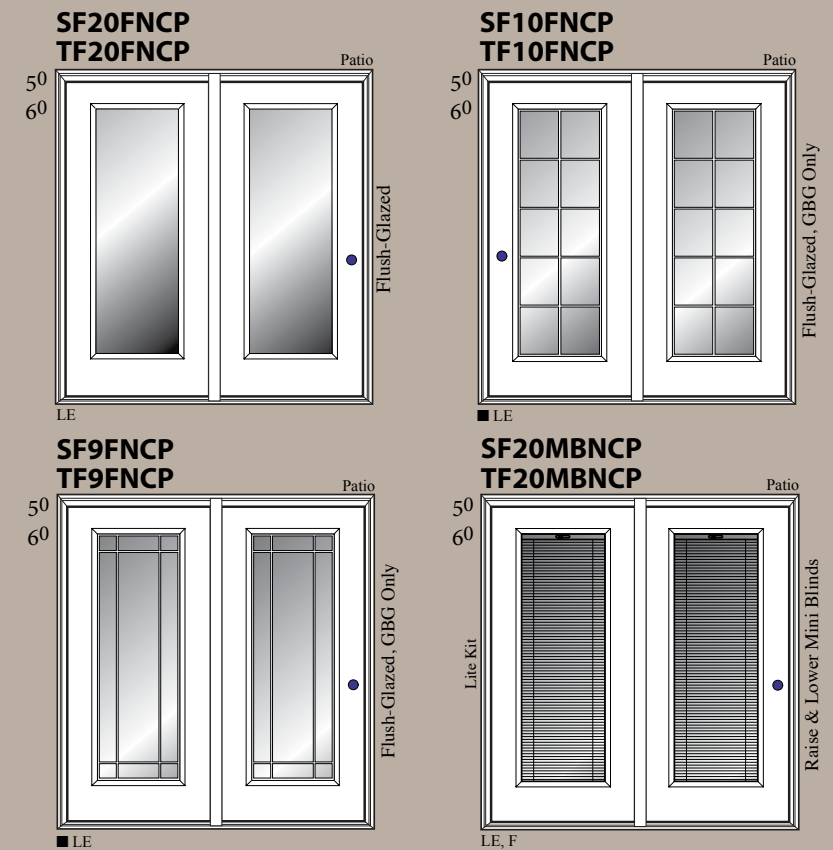

Net UNIT Heights

Door Width	Net UNIT Width	Adjustable Inswing Sill	Outswing Sill
5'0"	62-1/4"	81-3/4"	80-1/2"
6'0"	74-1/4"	81-3/4"	80-1/2"

See Page 78 for more information on our Retractable Screen.

Smooth & Textured Fiberglass EZ-Fit "Retro Sized" Double Doors (w/astragal)



SF20FEZ "Retro-Sized" door.

Key Code Chart

LE Available w/Low-E Glass

■ Available w/extended Leadtime.

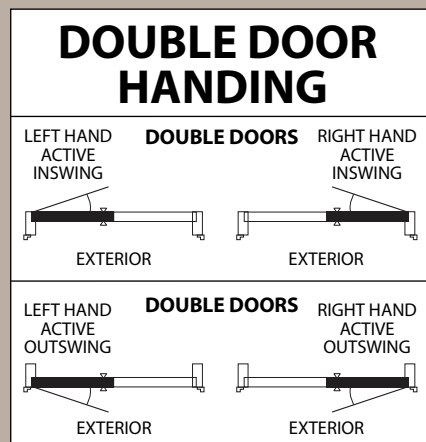
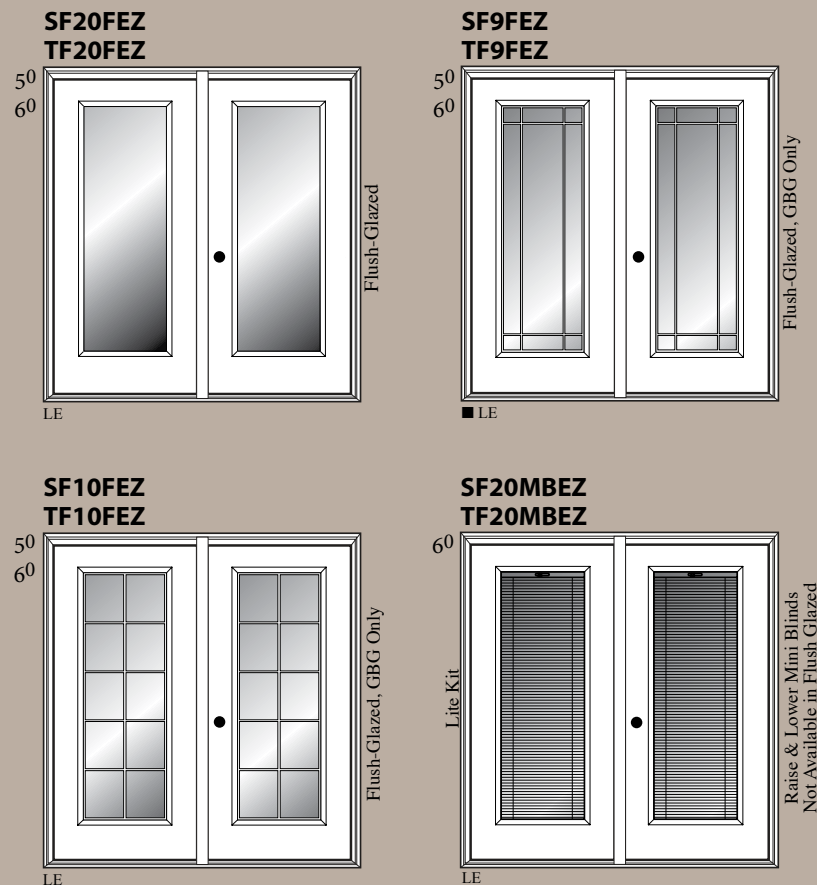

"EZ-Fit" Double Doors Net UNIT Sizes

Door Width	Net UNIT Width	Net UNIT Heights		
		Fixed or Adj. Inswing Sill	Bumper Outswing Sill	ADA Low-Pro In/Out Swing Sill
5'0" DBL	59"	79-1/2"	78-1/4"	78-3/4"
6'0" DBL	71"	79-1/2"	78-1/4"	78-3/4"

OBSCURE GLASS OPTIONS

CodeL offers a variety of obscure glass options. Obscurity levels range from glass that lets in plenty of light and definable detail to obscurity options offering increasing degrees of privacy.



Clear or Low-E



■ Satin Etch



■ Narrow Reed Vertical



■ Narrow Reed Horizontal



■ Rain



■ Rooftop



■ Sable



■ Seedy Reamy



■ White Laminate

*Additional obscure glass options are also available; contact CodeL for information.

■ SPECIAL ORDER -EXTENDED LEADTIME REQUIRED.

Steel Door Collection



Steel C61 door and CSL1 sidelite.



LIMITED
5
YEAR
WARRANTY



PREMIUM STEEL DOOR

- 24-gauge primed steel skins
- Composite bottom rail
- 12" wood lock block
- Polyurethane core

STEEL DOORS

The wood-edge steel door series is a popular choice for new construction as well as remodeling projects.

The versatility and thermal advantages of a wood-edge door are combined with the durability of 24-gauge steel facings. Units are permanently held in place by the adhesion of the polyurethane core.

After assembly, doors are primed for superior corrosion resistance. Wood-edge steel doors are available with a *20-minute fire rating for all 6'8" doors up to 3'0" wide. (*Excludes doors w/lite kits.)

Thermal Performance values established in accordance with the International Energy Conservation Code (IECC) section 102.3

	R value	U value	SHGC value
Steel door unit without Glass	6.25	0.16	0.00
Steel door unit with 1/4 Clear Glass	5.00	0.20	0.08
Steel door unit with 1/2 Clear Glass	3.85	0.26	0.19
Steel door unit with Full Clear Glass	2.78	0.36	0.34
Steel door unit with 1/2 LowE Glass	4.55	0.22	0.16
Steel door unit with Full LowE Glass	3.57	0.28	0.28
Steel door unit with 1/4 Decorative Glass	5.55	0.18	0.07
Steel door unit with 1/2 Decorative Glass	4.16	0.24	0.15
Steel door unit with 3/4 Decorative Glass	4.17	0.24	0.20
Steel door unit with Full Decorative Glass	3.45	0.29	0.27

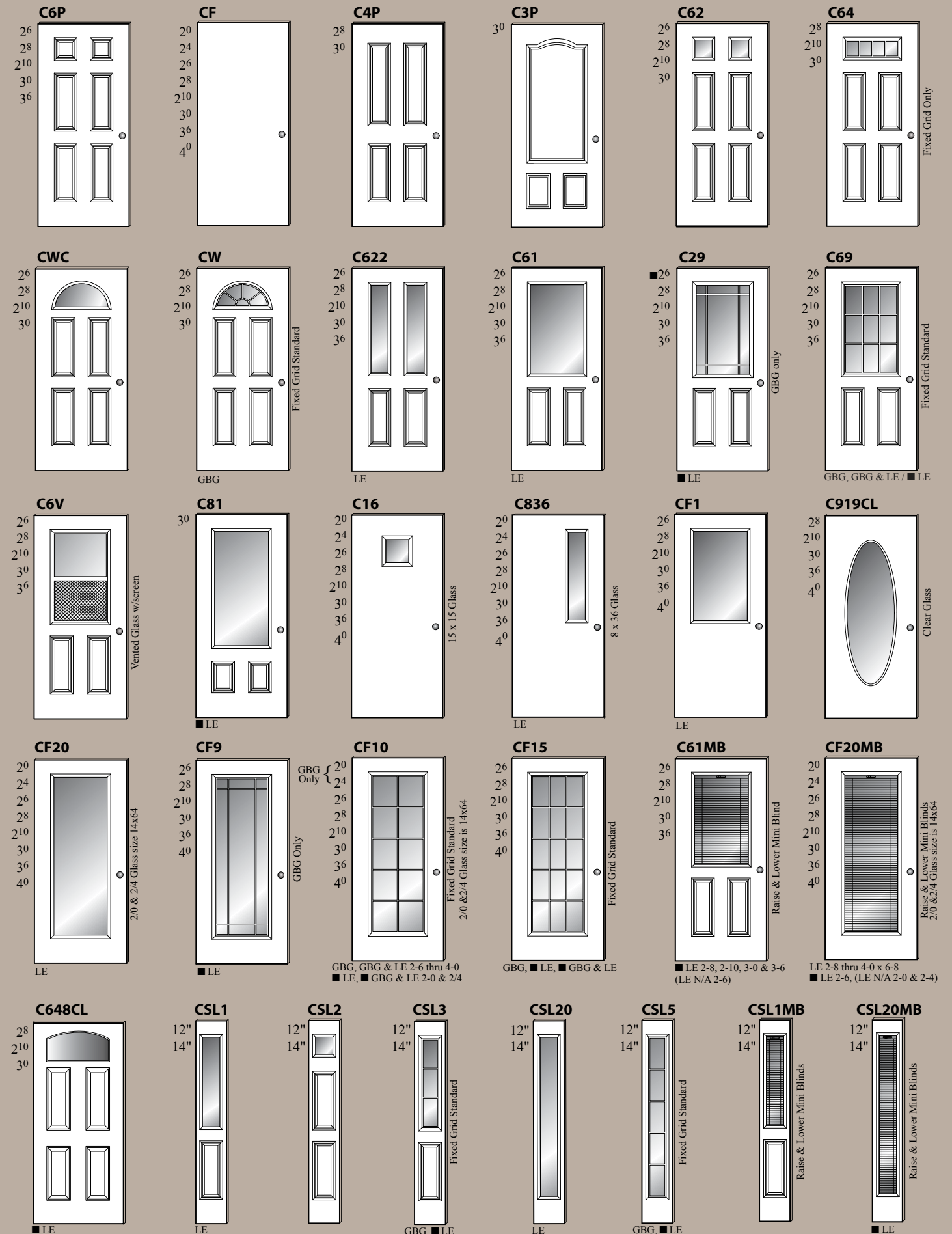

Key Code Chart

GBG Available w/Grids between Glass

LE Available w/Low-E Glass

■ Available w/extended Leadtime.

FAST-FRAME™

Introducing the Ultimate in Adjustable Steel Door Frames

FAST-FRAME'S advanced design adds a new dimension of flexibility and durability to Codel's steel entry door line. FAST-FRAME™ features closure kits with full 1" of adjustability to accommodate almost any variation in wall construction. This easy-to-install, user-friendly, kerfed steel door frame system is applicable to a full range of residential and commercial applications - wood or steel stud construction. FAST FRAME is engineered to meet the most stringent code requirements including structural, impact and 90-minute fire ratings.



C690 door.

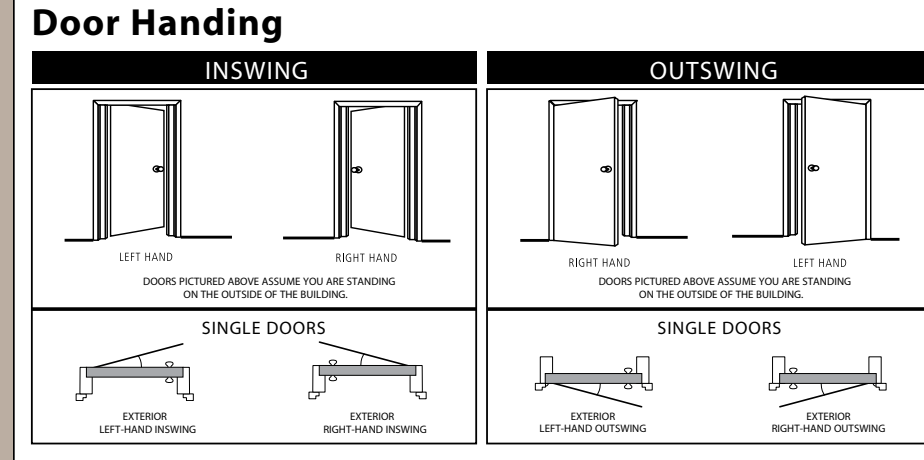

SILLS
Standard Inswing
Thermally broken - 5 5/8" width
Optional extenders for larger wall sizes
Note: Not for use on outswing applications.



Handicap (ADA)
Double Slope 5" and 7" width



Tile Face 5" and 7" width



Bumper Outswing 4 1/2" width

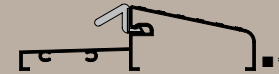

Adjustable T-Strike
1/4" of adjustment allows for ease of field installations for proper door closure

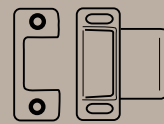

Closure Span Adjustment Chart

Wall Sizes
4 1/2" - 5 1/2"
5 1/2" - 6 1/2"
6 1/2" - 7 1/2"
7 1/2" - 8 1/2"
8 1/2" - 9 1/2"
9 1/2" - 10 1/2"

Weatherstripping
Schlegal foam-filled compression (QEBD500)
90 Min. Fire Rating

Prime Bright White EG
Galvanized 20-gauge steel to provide superior corrosion resistance and an optimal surface for painting

Outer Adjustable Closure
20-gauge Steel
2 uprights - 1 header

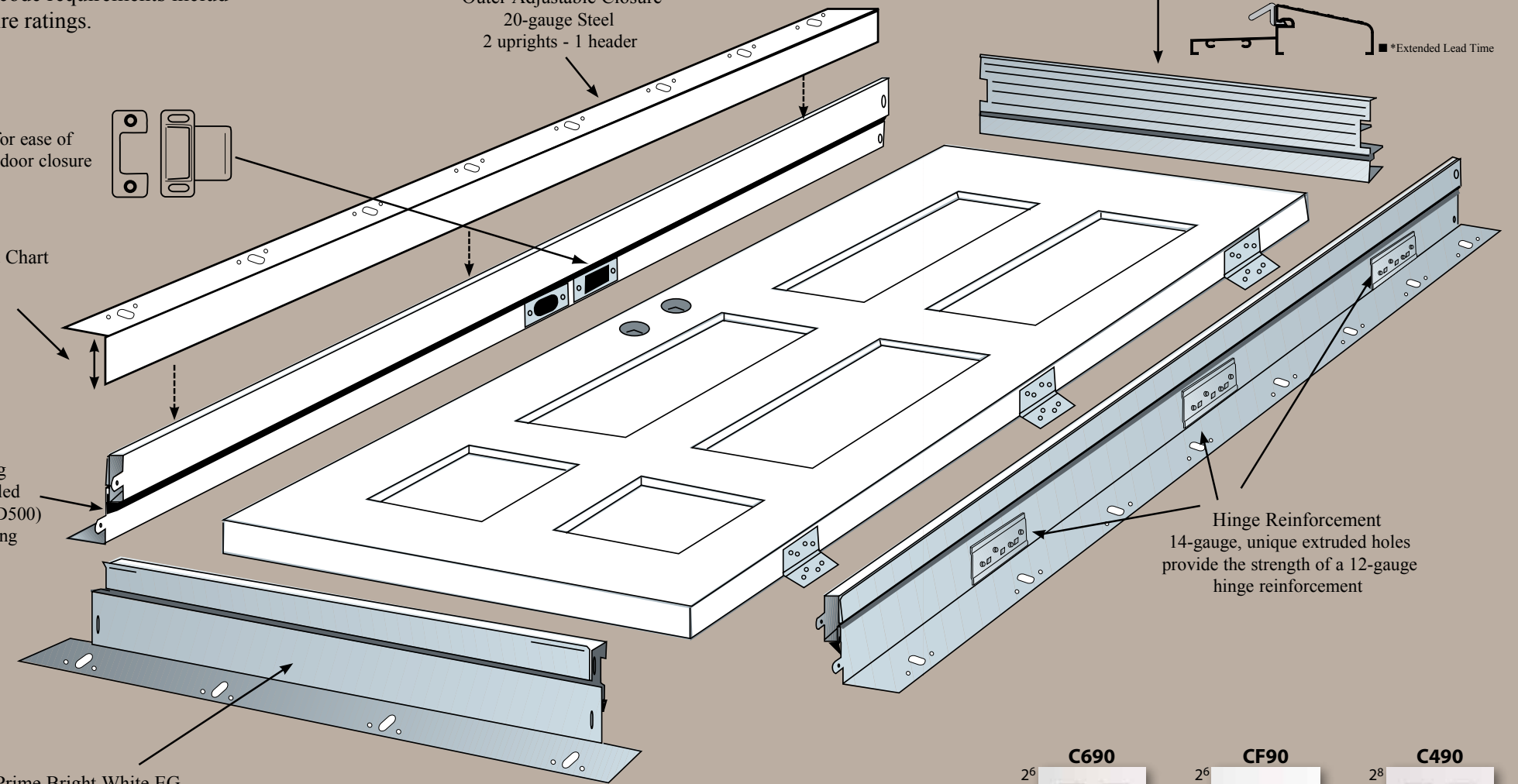

Hinge Reinforcement
14-gauge, unique extruded holes provide the strength of a 12-gauge hinge reinforcement

APPLICATIONS

- Multi-Family •Assisted Living •Motel/Hotel •House to Garage •Garage to Exterior



FIRE LABELS

90 Minute Fire Rating - up to 3'0" x 6'8".

CLOSURE TEST In a 90-minute application, the door will close and latch from 18" if the following Fast-Frame components are used:

- QEBD500 Foam-Filled Compression Weatherstripping
- Factory Sweep • Adjustable T-Strike • Factory Supplied Sills



STRUCTURAL PERFORMANCE AND IMPACT RATING

Design pressure ratings are available for compliance with national, state and local wind load and/or missile requirements. Product approval under the Miami-Dade BCCO NOA or Intertek Testing Services/Warnock Hersey® programs.

Prehung Door Sizes

Single Door	Slab Size	Net Unit Width	Net Unit Height STD Fixed Sill	Net Unit Height Low Pro Sill
2' 6" x 6' 8"	29-3/4" x 79-1/4"	31-1/4"	81-3/8"	80-3/4"
2' 8" x 6' 8"	31-3/4" x 79-1/4"	33-1/4"	81-3/8"	80-3/4"
2' 10" x 6' 8"	33-3/4" x 79-1/4"	35-1/4"	81-3/8"	80-3/4"
3' 0" x 6' 8"	35-3/4" x 79-1/4"	37-1/4"	81-3/8"	80-3/4"
3' 0" x 7' 0"	35-3/4" x 83-1/4"	37-1/4"	85-3/8"	84-3/4"

■ Extended Leadtime Required.

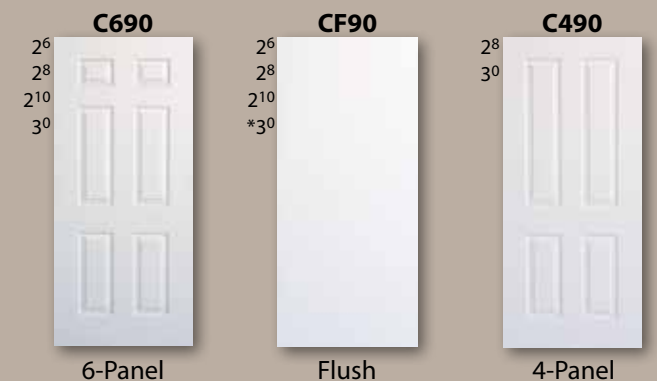

*Available in 7/0



Black Chrome Caming

PRIVACY RATING 5

clear — opaque

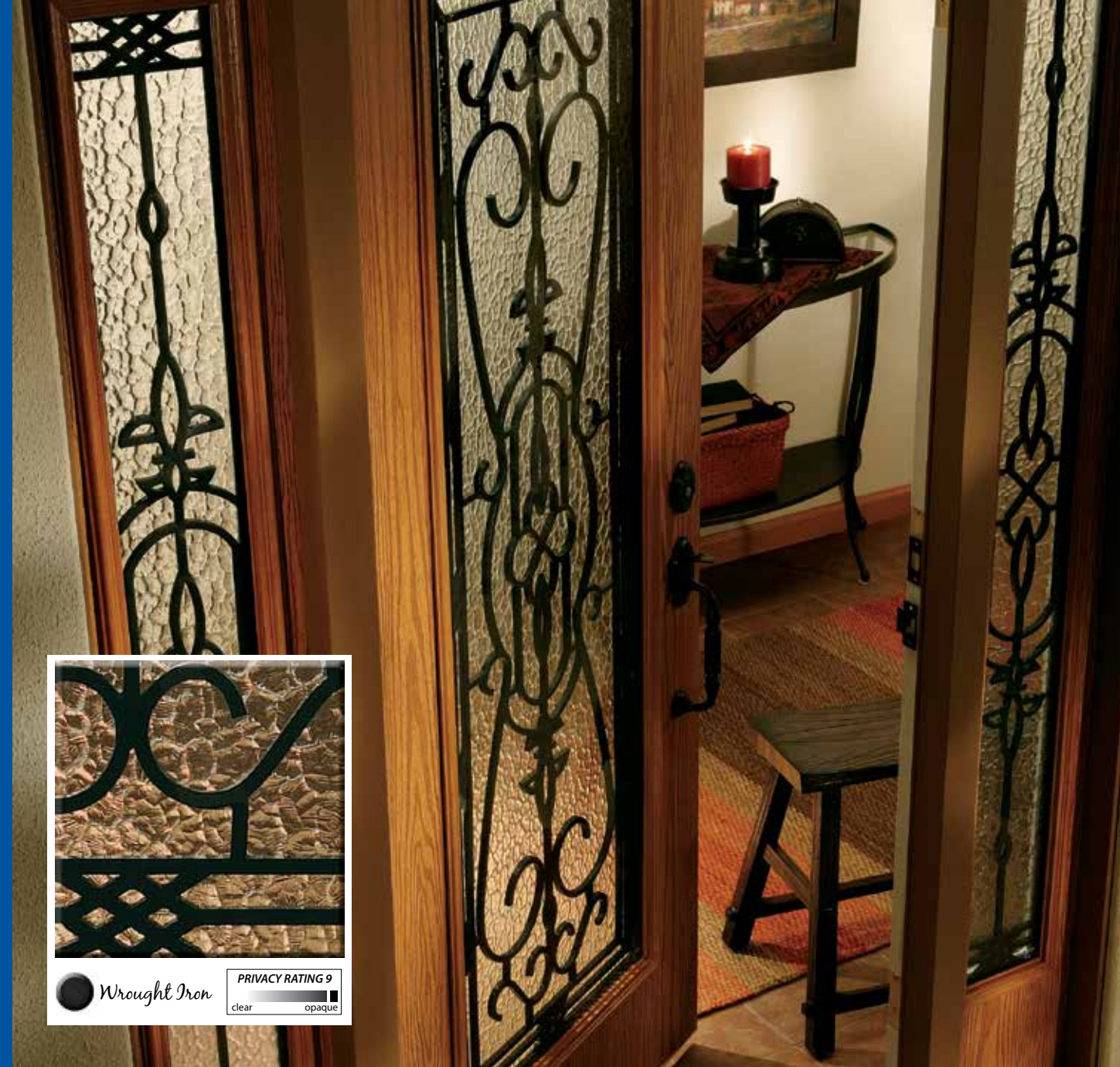

Wrought Iron

PRIVACY RATING 9

clear — opaque

Entropy Collection

6" ENTROPY

ENT-160 (L) (12" & 14")

ENT-460 (28 210 30)

ENT-160 (R) (12" & 14")

8" ENTROPY

ENT-16080 (L) (12" & 14")

ENT-46080 (30 36)

ENT-16080 (R) (12" & 14")

8" ENTROPY

ENT-280 (L) (12" & 14")

ENT-480 (28 30 36)

ENT-280 (R) (12" & 14")

Jacinto Collection

6" JACINTO

JAC-460 (28 210 30)

JAC-160 (12" & 14")

8" JACINTO

JAC-46080 (30 36)

JAC-16080 (12" & 14")

Jacinto Transoms

JAC-507 / JAC-521

JAC-532



8^o Natalia Entry Doors & Sidelites



NAT-24080
(SF - 28 30)
(TF - 30)



NAT-44080
(SF - 28 30)
(TF - 30)



NAT-440801P
(30)



NAT-24080
(12" & 14")



NAT-46080
(30 36)



NAT-16080
(12" & 14")

6^o Natalia Collection



NAT-440
(28 30)



NAT-240
(12" & 14")



NAT-460
(28 210 30)



NAT-160
(12" & 14")



NAT-200
(30)

(OPTIONAL)
C-21 Craftsman Shelf
(Available for Smooth and Textured Fiberglass NAT-200)



Textured Fiberglass Natalia NAT-460 door and NAT-160 sidelites.

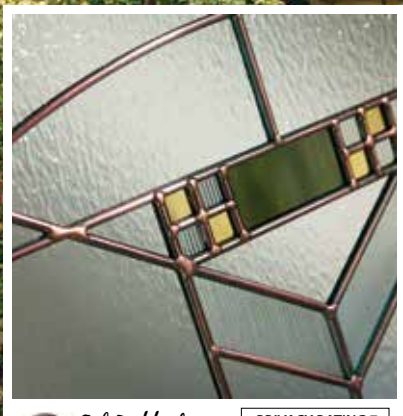

Oil Rubbed Bronze Caming
 PRIVACY RATING 7
 clear opaque

6⁸ Greenfield Collection

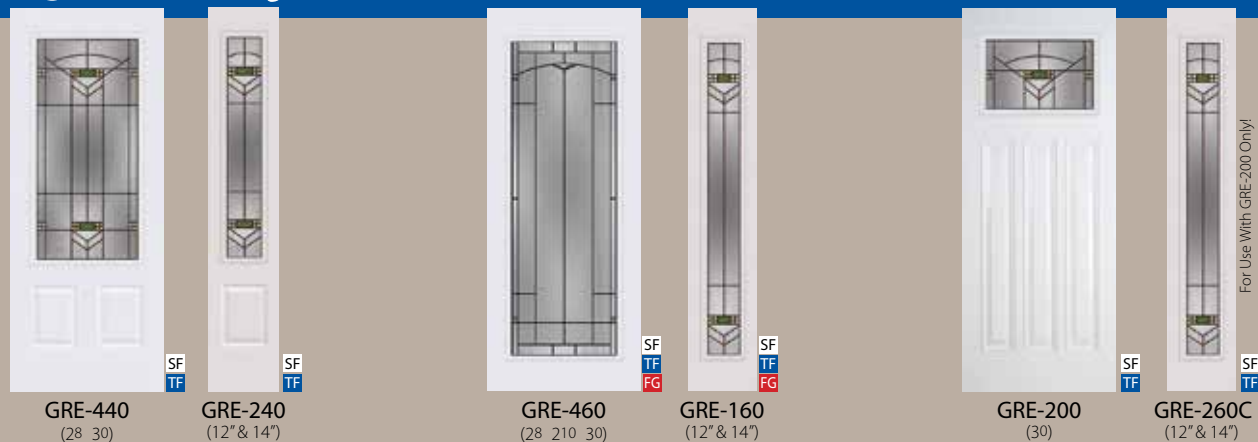

8⁰ Greenfield Entry Doors

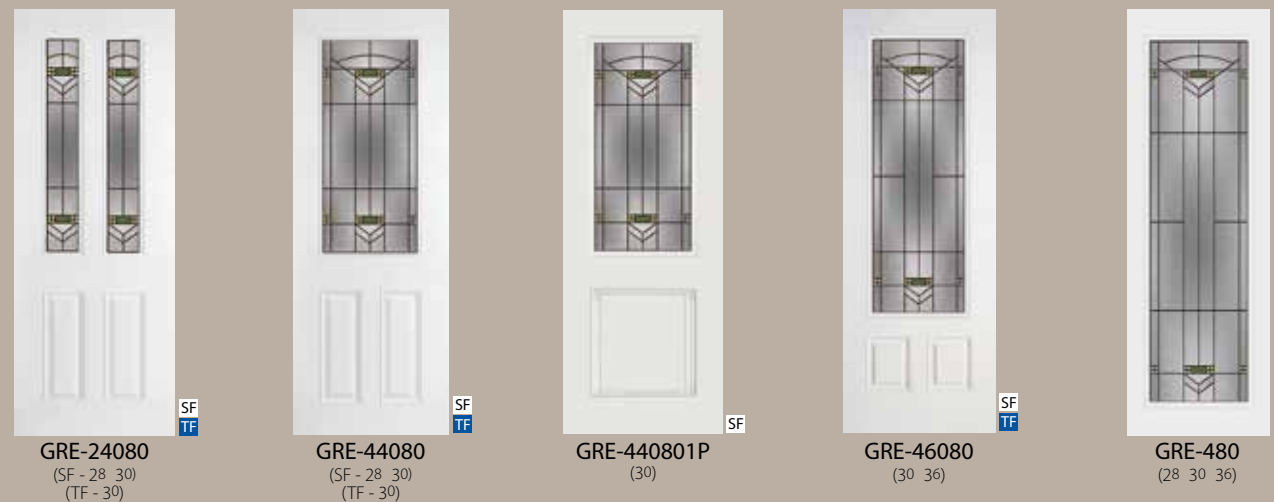

8⁰ Greenfield Sidelites

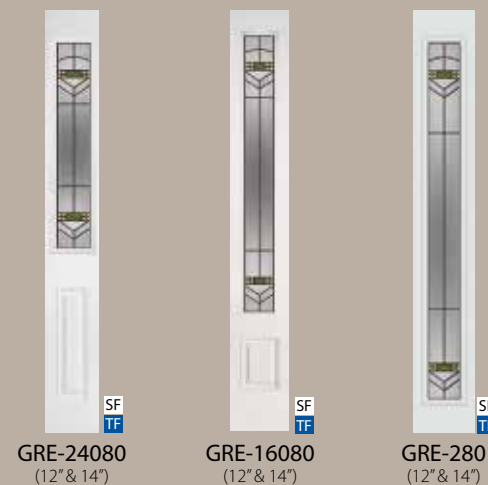

Greenfield Transom



GRE-521

(OPTIONAL)
C-21 Craftsman Shelf
 (Available for Smooth and Textured Fiberglass GRE-200)



Extended Leadtime Required. Refer to Page 88 for Transom Size Information.



Textured Fiberglass Greenfield GRE-460 door.



Palina Caming

PRIVACY RATING 3

clear — opaque

8° Legacy Master Entry Doors

- LEG-24080 (SF - 28 30) (TF - 30)
- LEG-44080 (SF - 28 30) (TF - 30)
- LEG-440801P (30)
- LEG-46080 (30 36)
- LEG-480 (28 30 36)

6° Legacy Master Sidelites

- LEG-230 (12" & 14")
- LEG-240 (12" & 14")
- LEG-160 (12" & 14")



Textured Fiberglass LEG-44080 door.

8° Legacy Master Sidelites

- LEG-24080 (12" & 14")
- LEG-16080 (12" & 14")
- LEG-280 (12" & 14")

6° Legacy Master Collection

- LEG-230 (26 28 210 30)
- LEG-430 (28 210 30)
- LEG-4301P (28 30)
- LEG-4301PC (28 30)
- LEG-440 (28 30)
- LEG-460 (28 210 30)
- LEG-949 (30)

Legacy Master Transoms

- LEG-506/507
- LEG-517

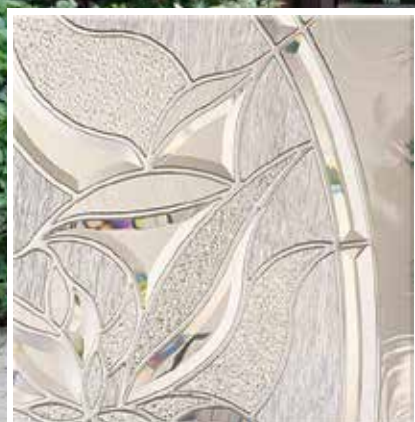

Cast Glass
(No Caming)

PRIVACY RATING 7
clear — opaque

8" Impressions Entry Doors & Sidelites



IMP-46080
(30 36)



IMP-16080
(12" & 14")



IMP-480
(28 30 36)



IMP-280
(12" & 14")

6" Impressions Sidelites



IMP-230
(12" & 14")



IMP-160
(12" & 14")



Smooth Fiberglass IMP-949 door.

6" Impressions Collection



IMP-400
(SF 28 210 30)
(TF 26 28 210 30)



IMP-230
(26 28 210 30)



IMP-430
(28 210 30)



IMP-4301P
(28 30)



IMP-4301PC
(28 30)



IMP-460
(28 210 30)



IMP-949
(30)

Impressions Transom



IMP-507

Extended Leadtime Required. Refer to Page 88 for Transom Size Information.



8° Oak Park Entry Doors



6° Oak Park Sidelites

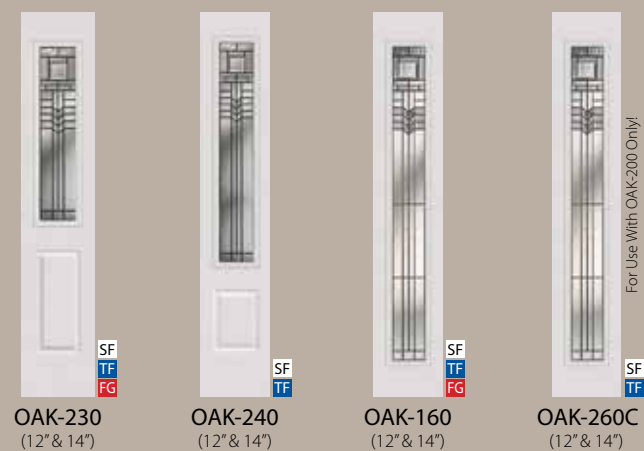

Oak Park Transoms



8° Oak Park Sidelites

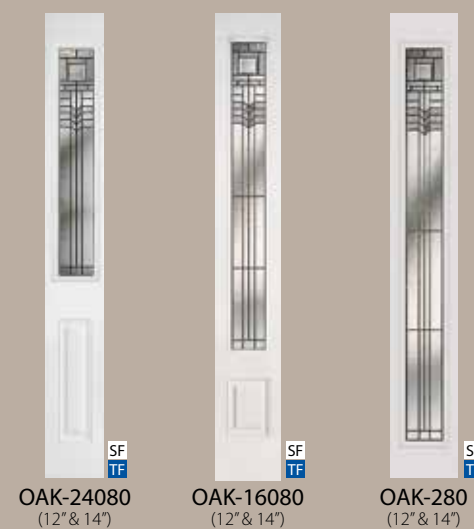

Smooth Fiberglass OAK-440 door.

6° Oak Park Collection



(OPTIONAL)
C-21 Craftsman Shelf
 (Available for Smooth and Textured Fiberglass OAK-200)



■ Extended Leadtime Required. Refer to Page 88 for Transom Size Information.



Patina Caming

PRIVACY RATING 8

clear — opaque

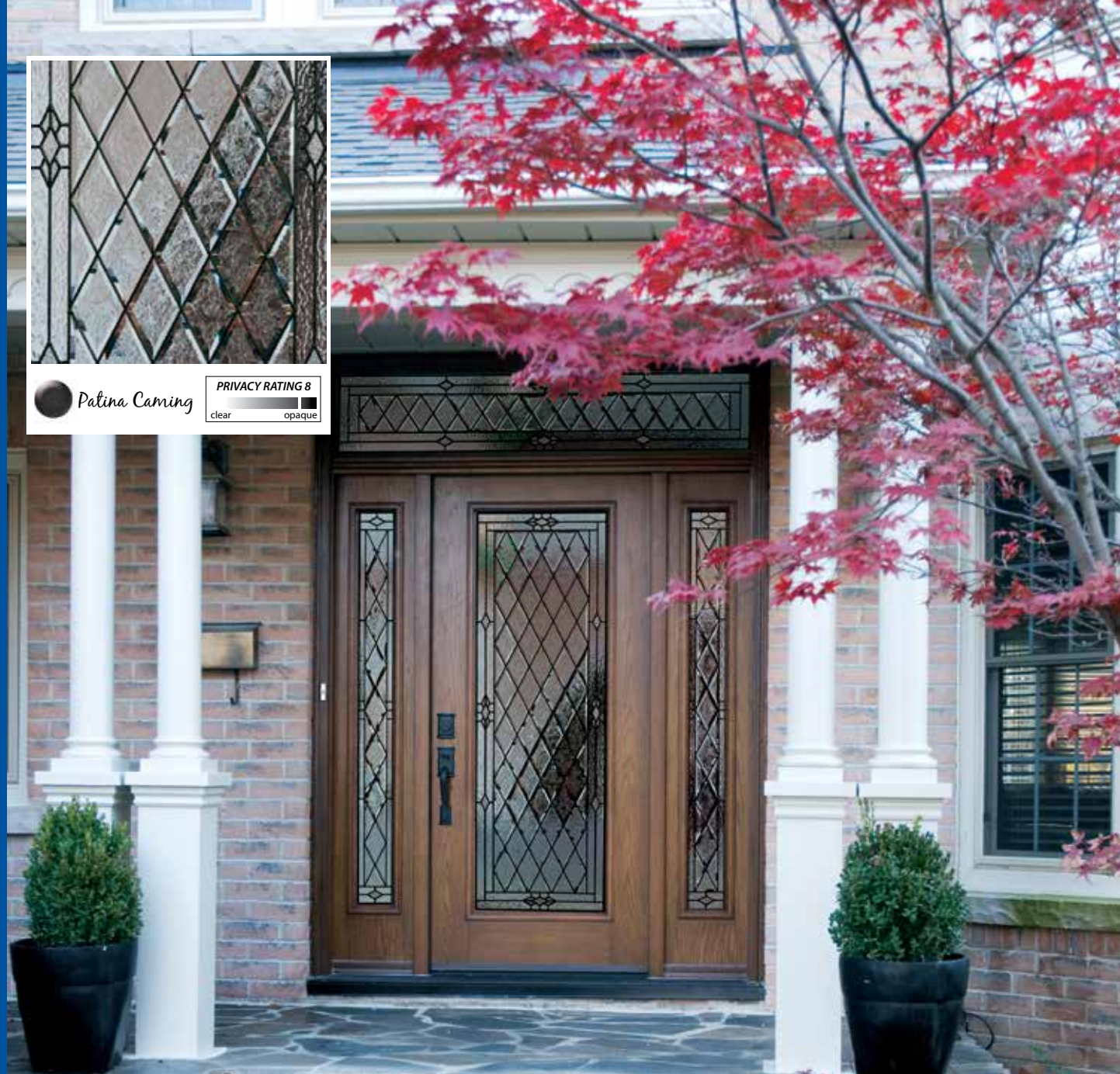

6⁸ Canterbury Collection



CAN-230 (26 28 210 30) CAN-430 (28 210 30) CAN-4301P (28 30) CAN-4301PC (28 30) CAN-440 (28 30) CAN-460 (28 210 30) CAN-949 (30)

8⁰ Canterbury Entry Doors



CAN-24080 (SF - 28 30) (TF - 30) CAN-44080 (SF - 28 30) (TF - 30) CAN-440801P (30) CAN-46080 (30 36)

6⁸ Canterbury Sidelites



CAN-230 (12" & 14") CAN-240 (12" & 14") CAN-160 (12" & 14")

8⁰ Canterbury Sidelites



CAN-24080 (12" & 14") CAN-16080 (12" & 14")



Textured Fiberglass Canterbury CAN-46080 door with CAN-16080 sidelite.

Canterbury Transom



Extended Leadtime Required. Refer to Page 88 for Transom Size Information.

CAN-6212 / CAN-6612 / CAN-7212

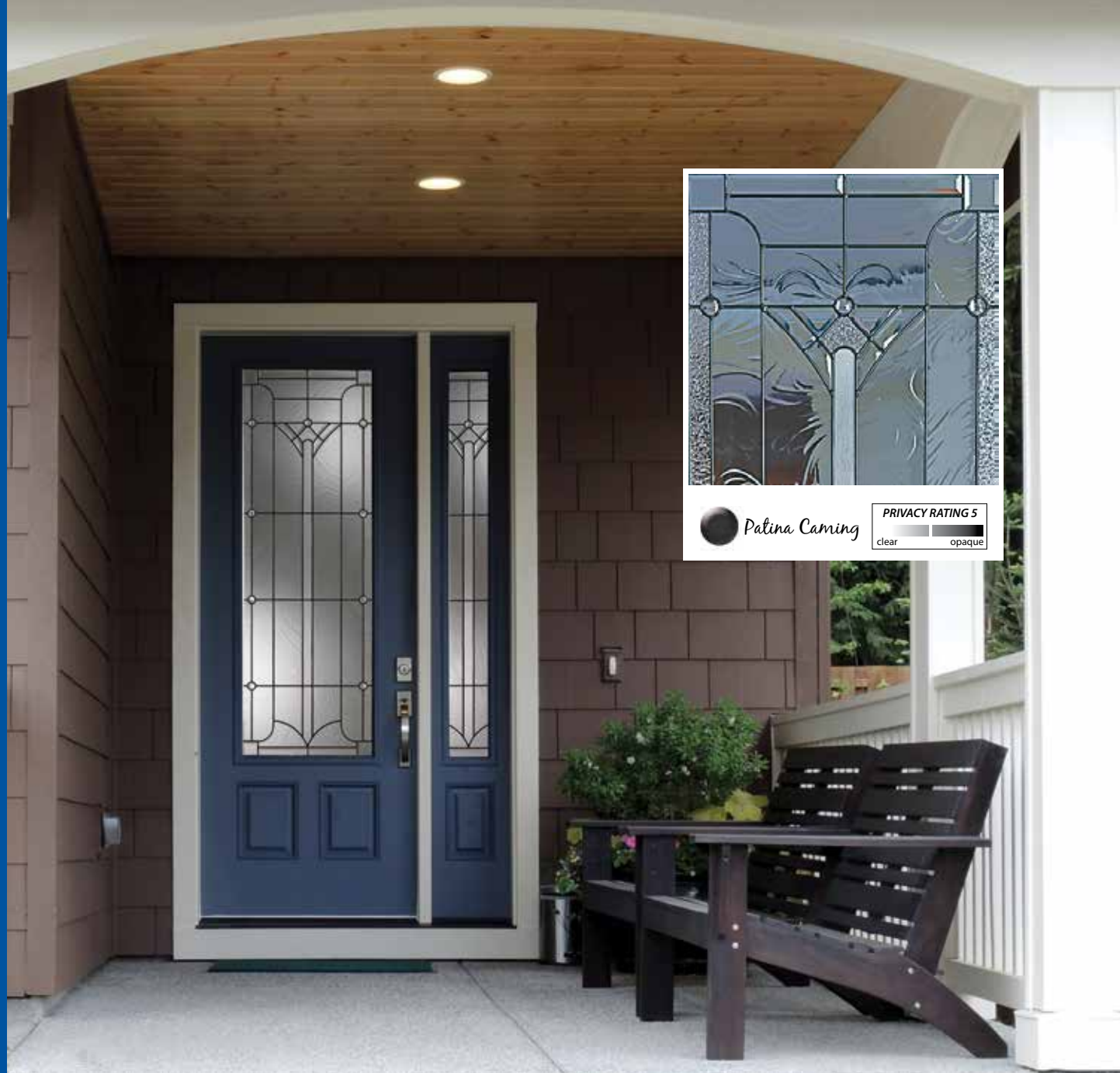

Patina Caming

PRIVACY RATING 5
clear — opaque

6⁸ Waterton Collection



WAT-230 (26 28 210 30) WAT-430 (28 210 30) WAT-4301P (28 30) WAT-4301PC (28 30) WAT-440 (28 30) WAT-460 (28 210 30) WAT-200 (30) WAT-64 (30)

SF Smooth Fiberglass TF Textured Fiberglass FG Fir Grain Textured Fiberglass

8⁰ Waterton Entry Doors

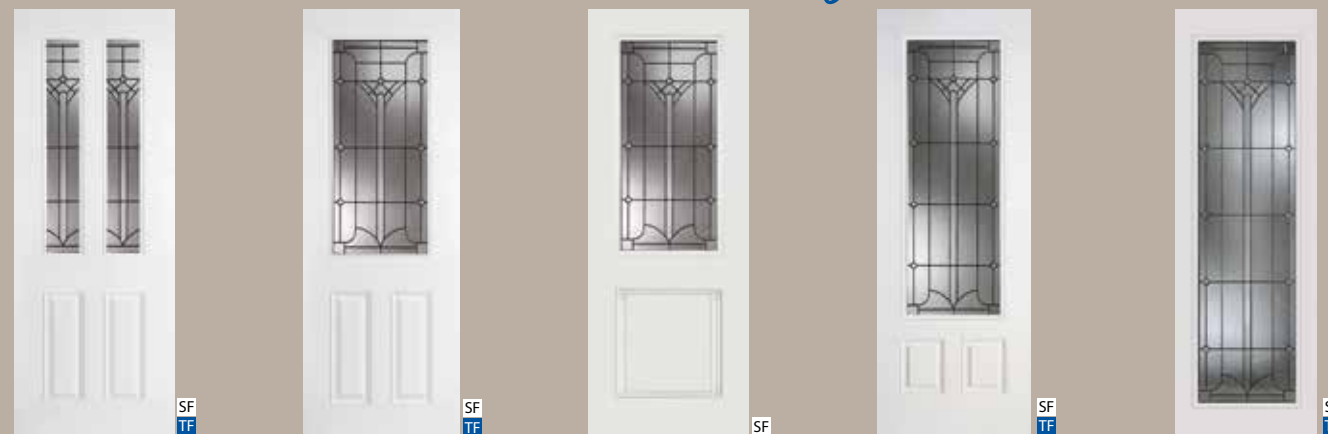

WAT-24080 (SF - 28 30) (TF - 30) WAT-44080 (SF - 28 30) (TF - 30) WAT-440801P (30) WAT-46080 (30 36) WAT-480 (28 30 36)

6⁸ Waterton Sidelites

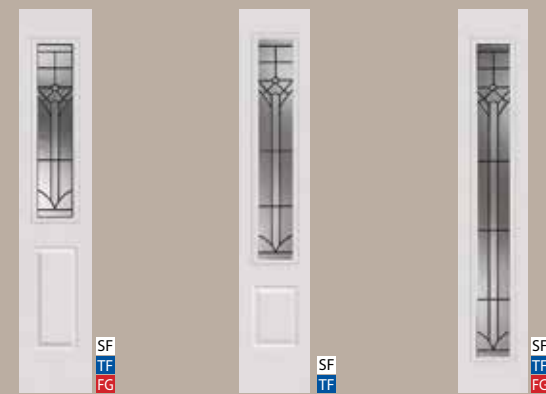

WAT-230 (12" & 14") WAT-240 (12" & 14") WAT-160 (12" & 14")

8⁰ Waterton Sidelites

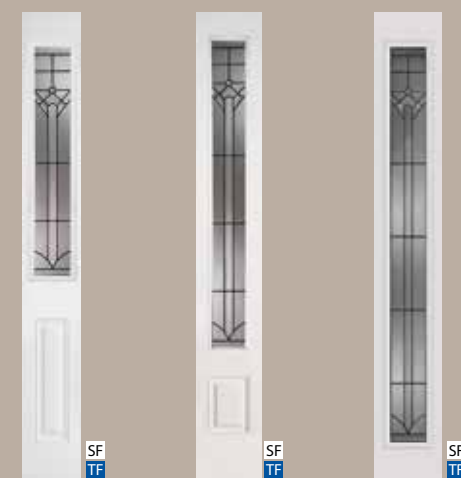

WAT-24080 (12" & 14") WAT-16080 (12" & 14") WAT-280 (12" & 14")

(OPTIONAL)
C-21 Craftsman Shelf

(Available for Smooth and Textured Fiberglass WAT-200)



Extended Leadtime Required. Refer to Page 88 for Transom Size Information.

Waterton Transom



WAT-6212 / WAT-6612 / WAT-7212



Textured Fiberglass WAT-430 door.



6⁸ Brentwood Collection



8⁰ Brentwood Entry Doors



6⁸ Brentwood Sidelites



8⁰ Brentwood Sidelites



Brentwood Transoms



Textured Fiberglass BRE-253 door.

(OPTIONAL) C-21 Craftsman Shelf

(Available for Smooth and Textured Fiberglass BRE-200)



Refer to Page 88 for Transom Size Information.

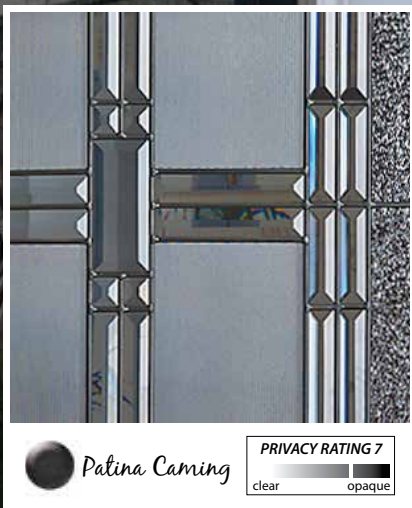

Patina Caming
 PRIVACY RATING 7
 clear — opaque

8° Artisan Entry Doors

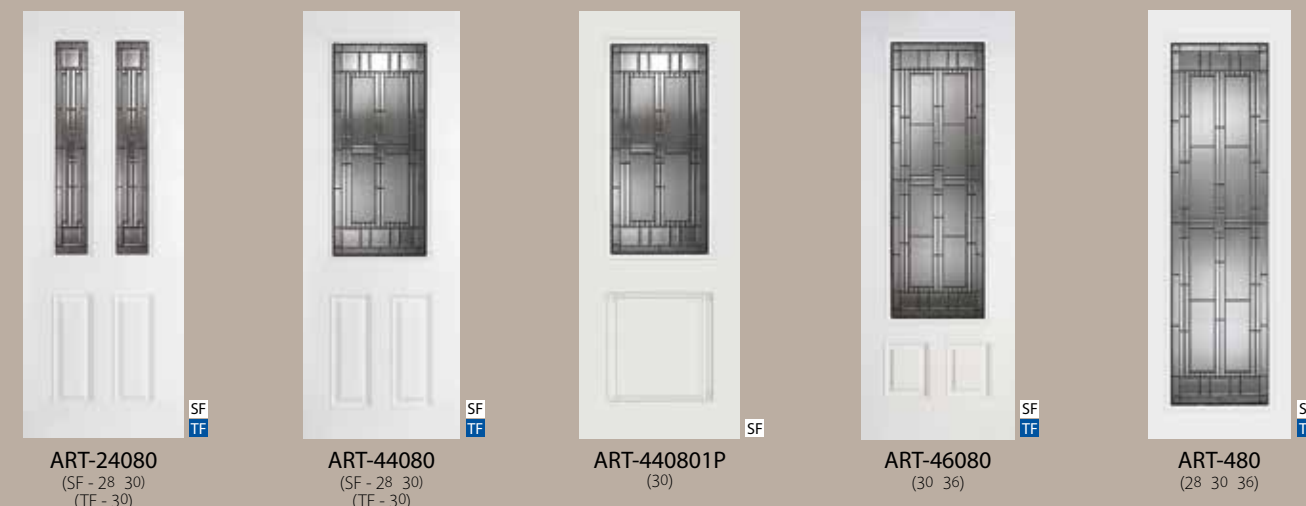

ART-24080 (SF - 28 30) (TF - 30) ART-44080 (SF - 28 30) (TF - 30) ART-440801P (30) ART-46080 (30 36) ART-480 (28 30 36)

6° Artisan Sidelites

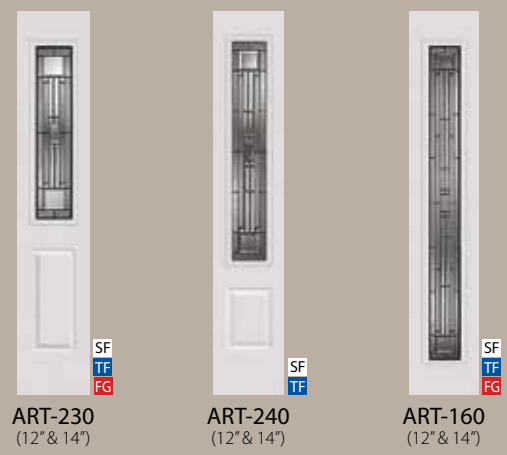

ART-230 (12" & 14") ART-240 (12" & 14") ART-160 (12" & 14")

Artisan Transoms

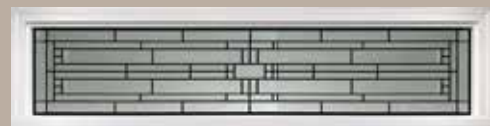

ART-602 / ART-603

8° Artisan Sidelites



ART-24080 (12" & 14") ART-16080 (12" & 14") ART-280 (12" & 14")



Textured Fiberglass ART-430 door .

6° Artisan Collection



ART-230 (26 28 210 30) ART-430 (28 210 30) ART-4301P (28 30) ART-4301PC (28 30) ART-440 (28 30) ART-460 (28 210 30) ART-200 (30)

(OPTIONAL)
C-21 Craftsman Shelf
 (Available for Smooth and Textured Fiberglass ART-200)



Extended Leadtime Required. Refer to Page 88 for Transom Size Information.

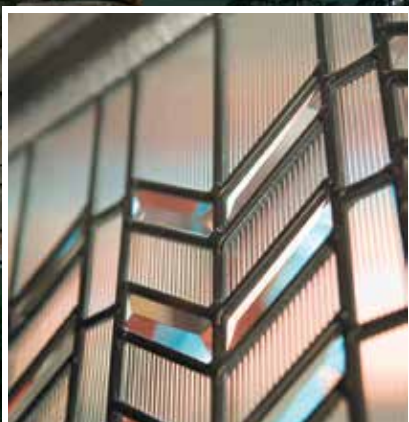

Palina Caming
 PRIVACY RATING 6
 clear — opaque

8° Prairie Bevel Entry Doors



PRA-24080
 (SF - 28 30)
 (TF - 30)



PRA-44080
 (SF - 28 30)
 (TF - 30)



PRA-440801P
 (30)



PRA-46080
 (30 36)

6° Prairie Bevel Sidelites



PRA-230
 (12" & 14")



PRA-240
 (12" & 14")



PRA-160
 (12" & 14")



PRA-260C
 (12" & 14")

For Use With PRA-200 Only!

8° Prairie Bevel Sidelites



PRA-24080
 (12" & 14")



PRA-16080
 (12" & 14")

(OPTIONAL) C-21 Craftsman Shelf

(Available for Smooth and Textured Fiberglass PRA-200)



Smooth Fiberglass PRA-4301PC door.

6° Prairie Bevel Collection



PRA-230
 (26 28 210 30)



PRA-430
 (28 210 30)



PRA-4301P
 (28 30)



PRA-4301PC
 (28 30)



PRA-440
 (28 30)



PRA-460
 (28 210 30)



PRA-200
 (30)

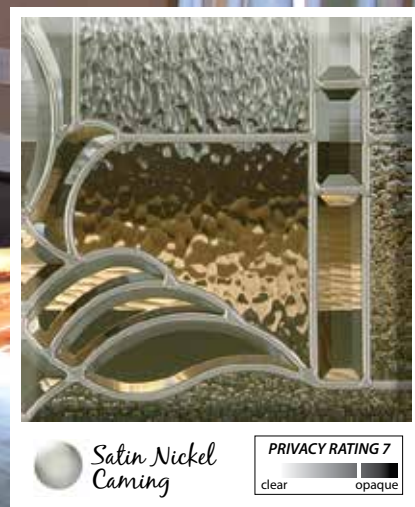

6⁸ Bristol Collection



BRI-230 (26 28 210 30) BRI-430 (28 210 30) BRI-4301P (28 30) BRI-4301PC (28 30) BRI-440 (28 30) BRI-460 (28 210 30)

8⁰ Bristol Entry Doors



BRI-24080 (SF - 28 30) (TF - 30) BRI-44080 (SF - 28 30) (TF - 30) BRI-440801P (30) BRI-46080 (30 36) BRI-480 (28 30 36)

Bristol Transom



■ BRI-506

6⁸ Bristol Sidelites



BRI-230 (12" & 14") BRI-240 (12" & 14") BRI-160 (12" & 14")

8⁰ Bristol Sidelites



BRI-24080 (12" & 14") BRI-16080 (12" & 14") BRI-280 (12" & 14")



Textured Fiberglass BRI-440 door.

■ Extended Leadtime Required. Refer to Page 88 for Transom Size Information.



8° Camden Entry Doors



CAM-24080
(SF - 28 30)
(TF - 30)



CAM-44080
(SF - 28 30)
(TF - 30)



CAM-440801P
(30)

6° Camden Sidelites



CAM-230
(12" & 14")



CAM-240
(12" & 14")



CAM-160
(12" & 14")

8° Camden Sidelites



CAM-24080
(12" & 14")



CAM-16080
(12" & 14")



Textured Fiberglass Camden CAM-949 door.

6° Camden Collection



CAM-230
(26 28 210 30)



CAM-430
(28 210 30)



CAM-4301P
(28 30)



CAM-4301PC
(28 30)



CAM-440
(28 30)



CAM-949
(30)



8° Topaz Entry Doors

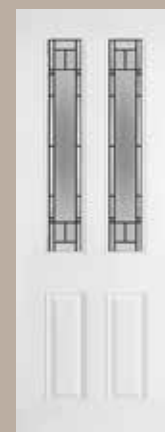

TOP-24080
(SF - 28 30)
(TF - 30)



TOP-44080
(SF - 28 30)
(TF - 30)



TOP-440801P
(30)

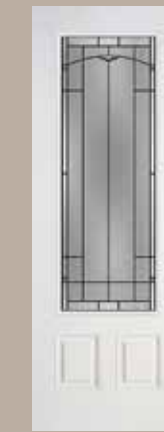

TOP-46080
(30 36)

6° Topaz Sidelites



Smooth Fiberglass Topaz TOP-200 door.
Shown with optional C-21 shelf.



TOP-230
(12" & 14")



TOP-240
(12" & 14")



TOP-160
(12" & 14")

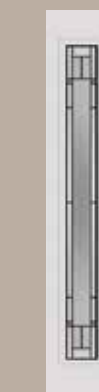

TOP-260C
(12" & 14")

For Use With TOP-200 Only!

8° Topaz Sidelites



TOP-24080
(12" & 14")



TOP-16080
(12" & 14")

6° Topaz Collection



TOP-230
(26 28 210 30)



TOP-430
(28 210 30)

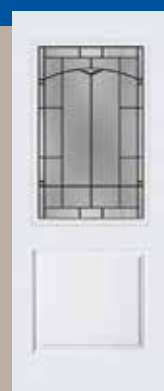

TOP-4301P
(28 30)



TOP-4301PC
(28 30)



TOP-440
(28 30)



TOP-460
(28 210 30)



TOP-200
(30)

(OPTIONAL) C-21 Craftsman Shelf

(Available for Smooth and Textured Fiberglass TOP-200)





8° Adelaide Entry Doors



ADE-24080
(SF - 28 30)
(TF - 30)



ADE-44080
(SF - 28 30)
(TF - 30)



ADE-440801P
(30)

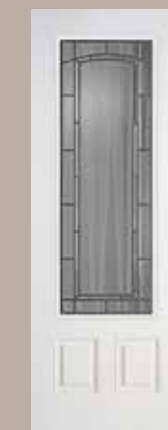

ADE-46080
(30 36)

6° Adelaide Sidelites



ADE-230
(12" & 14")



ADE-240
(12" & 14")



ADE-160
(12" & 14")

Adelaide Transom



■ ADE-6212 / ADE-6612 / ADE-7212

8° Adelaide Sidelites



ADE-24080
(12" & 14")



ADE-16080
(12" & 14")

(OPTIONAL)
C-21 Craftsman Shelf
(Available for Smooth and Textured Fiberglass ADE-200)

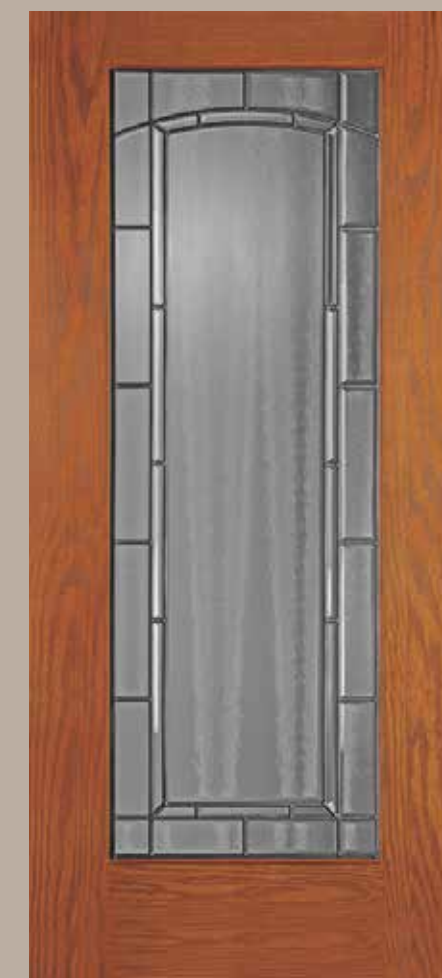

Textured Fiberglass Adelaide ADE-460 door.

6° Adelaide Collection



ADE-230
(26 28 210 30)



ADE-430
(28 210 30)

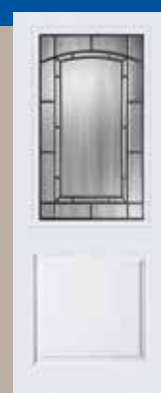

ADE-4301P
(28 30)



ADE-4301PC
(28 30)



ADE-440
(28 30)

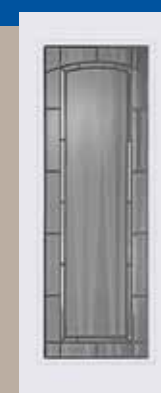

ADE-460
(28 210 30)



ADE-200
(30)

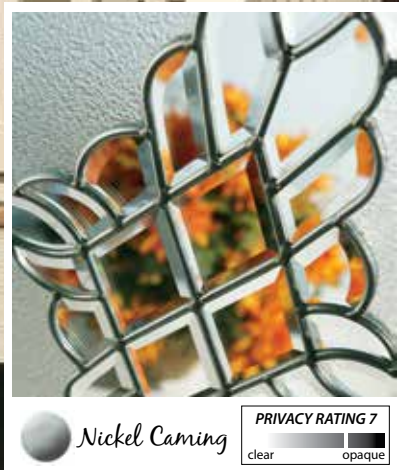

Nickel Caming
PRIVACY RATING 7
clear — opaque

6⁸ Grace Collection



GRC-400 (28 210 30) (TF 26 28 210 30)
 GRC-648 (28 210 30)
 GRC-230 (26 28 210 30)
 GRC-430 (28 210 30)
 GRC-4301P (28 30)
 GRC-4301PC (28 30)

6⁸ Grace Entry Doors



GRC-440 (28 30)
 GRC-460 (28 210 30)
 GRC-949 (30)
 GRC-919 (SF 28 210 30) (TF 28 30)

8⁰ Grace Entry Doors

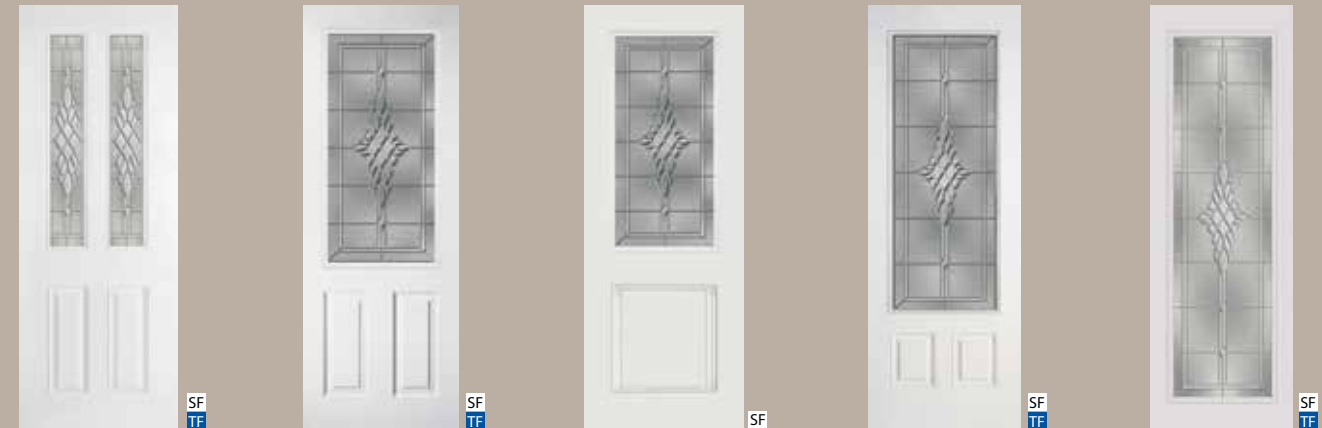

GRC-24080 (SF - 28 30) (TF - 30)
 GRC-44080 (SF - 28 30) (TF - 30)
 GRC-440801P (30)
 GRC-46080 (30 36)
 GRC-480 (28 30 36)

8⁰ Grace Sidelites

6⁸ Grace Sidelites

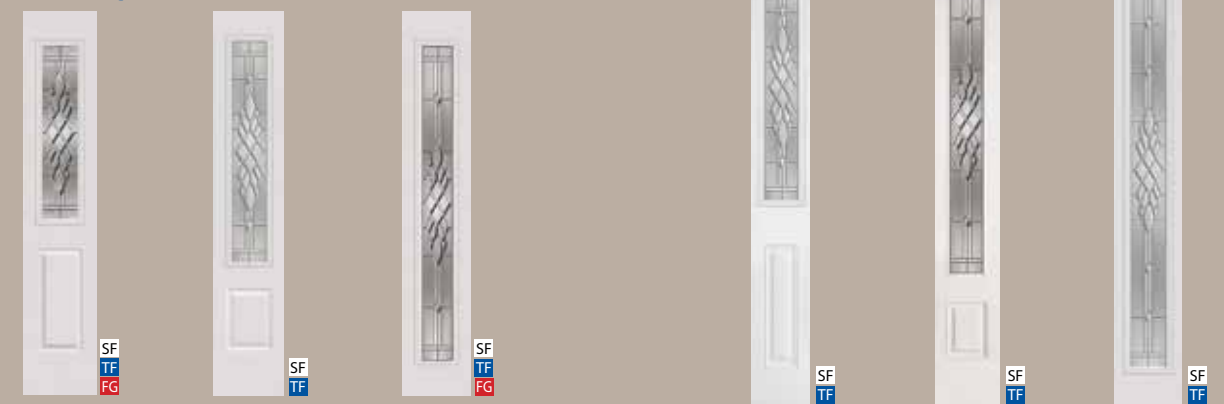

GRC-230 (12" & 14")
 GRC-240 (12" & 14")
 GRC-160 (12" & 14")
 GRC-24080 (12" & 14")
 GRC-16080 (12" & 14")
 GRC-280 (12" & 14")



8° Eloquence Entry Doors



ELO-24080
(SF - 28 30)
(TF - 30)



ELO-44080
(SF - 28 30)
(TF - 30)



ELO-440801P
(30)



ELO-46080
(30 36)

6° Eloquence Sidelites



ELO-230
(12" & 14")

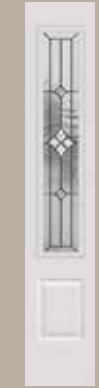

ELO-240
(12" & 14")

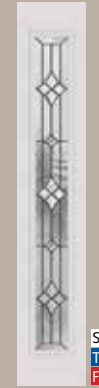

ELO-160
(12" & 14")

8° Eloquence Sidelites



ELO-24080
(12" & 14")



ELO-16080
(12" & 14")

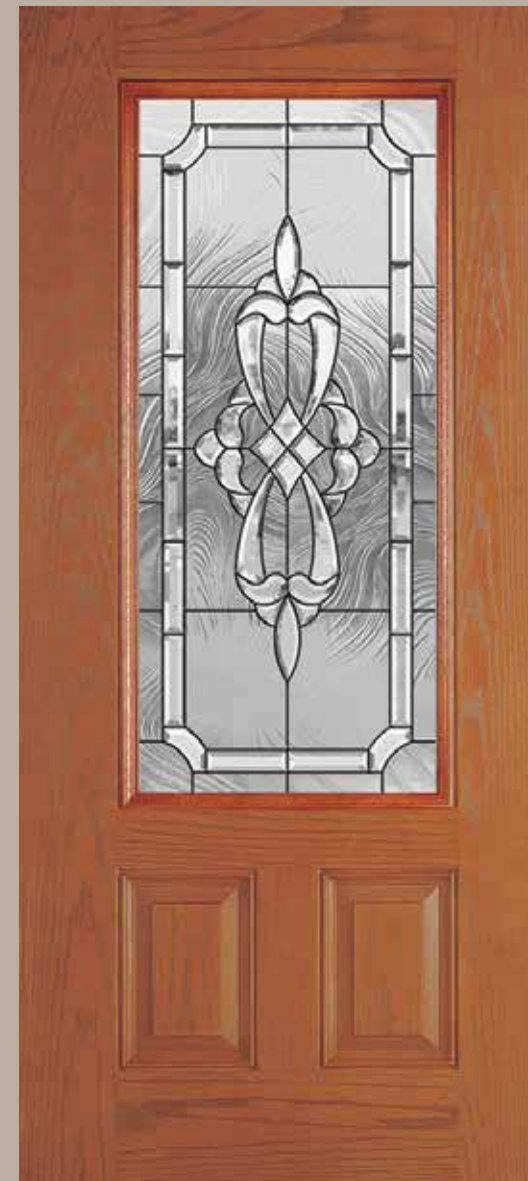

Textured Fiberglass Eloquence ELO-440 door.

6° Eloquence Collection



ELO-400
(SF 28 210 30)
(TF 26 28 210 30)



ELO-230
(26 28 210 30)



ELO-430
(28 210 30)



ELO-4301P
(28 30)



ELO-4301PC
(28 30)



ELO-440
(28 30)



ELO-460
(28 210 30)



Patina Caming **PRIVACY RATING 8**
 clear — opaque

8" Sonora Entry Doors



SON-24080
 (SF - 28, 30)
 (TF - 30)



SON-44080
 (SF - 28, 30)
 (TF - 30)



SON-440801P
 (30)



SON-46080
 (30, 36)

6" Sonora Sidelites



SON-230
 (12" & 14")



SON-240
 (12" & 14")



SON-160
 (12" & 14")



SON-24080
 (12" & 14")



SON-16080
 (12" & 14")

8" Sonora Sidelites

6" Sonora Collection



SON-230
 (26, 28, 210, 30)



SON-430
 (28, 210, 30)



SON-4301P
 (28, 30)



SON-4301PC
 (28, 30)



SON-440
 (28, 30)

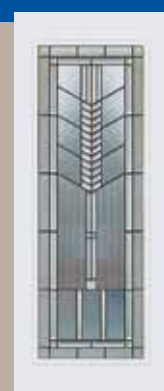

SON-460
 (28, 210, 30)



Smooth Fiberglass Sonora SON-44080 doors.



Zinc Caming

PRIVACY RATING 8
clear — opaque

8° Inspire Entry Doors



INS-24080
(SF - 28 30)
(TF - 30)



INS-44080
(SF - 28 30)
(TF - 30)



INS-440801P
(30)

6° Inspire Sidelites



INS-230
(12" & 14")



INS-240
(12" & 14")



Smooth Fiberglass Inspire INS-4301P.

8° Inspire Sidelites



INS-24080
(12" & 14")

6° Inspire Collection



INS-400
(SF 28 210 30)
(TF 26 28 210 30)



INS-230
(26 28 210 30)



INS-430
(28 210 30)



INS-4301P
(28 30)



INS-4301PC
(28 30)



INS-440
(28 30)



-  Zinc Caming
-  Brass Caming
-  Patina Caming

PRIVACY RATING 6
 clear  opaque

6⁸ Nouveau Collection



B = Brass Z = Zinc P = Patina

6⁸ Nouveau Entry Doors

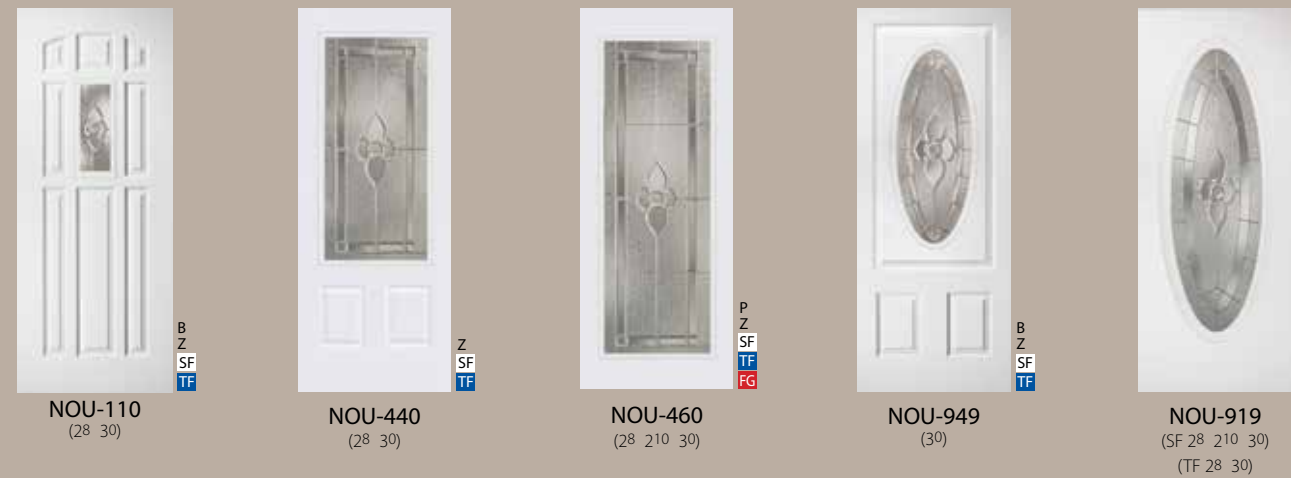

6⁸ Nouveau Sidelites

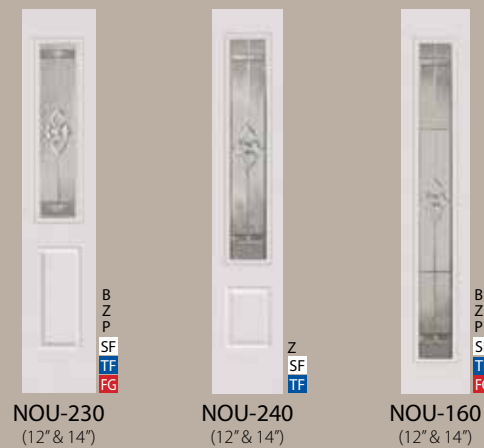

Nouveau Transoms

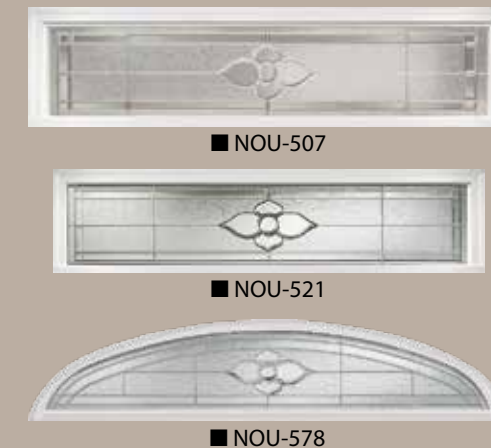

8⁰ Nouveau Entry Doors

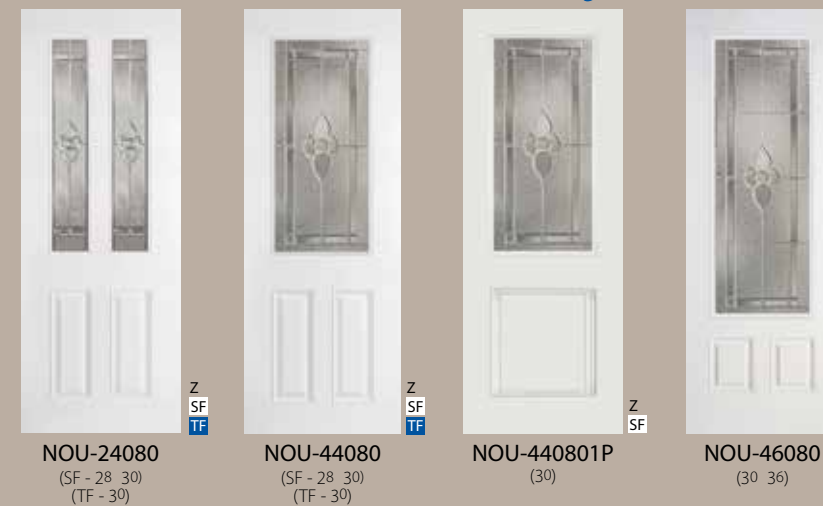

8⁰ Nouveau Sidelites



■ Extended Leadtime Required. Refer to Page 88 for Transom Size Information.

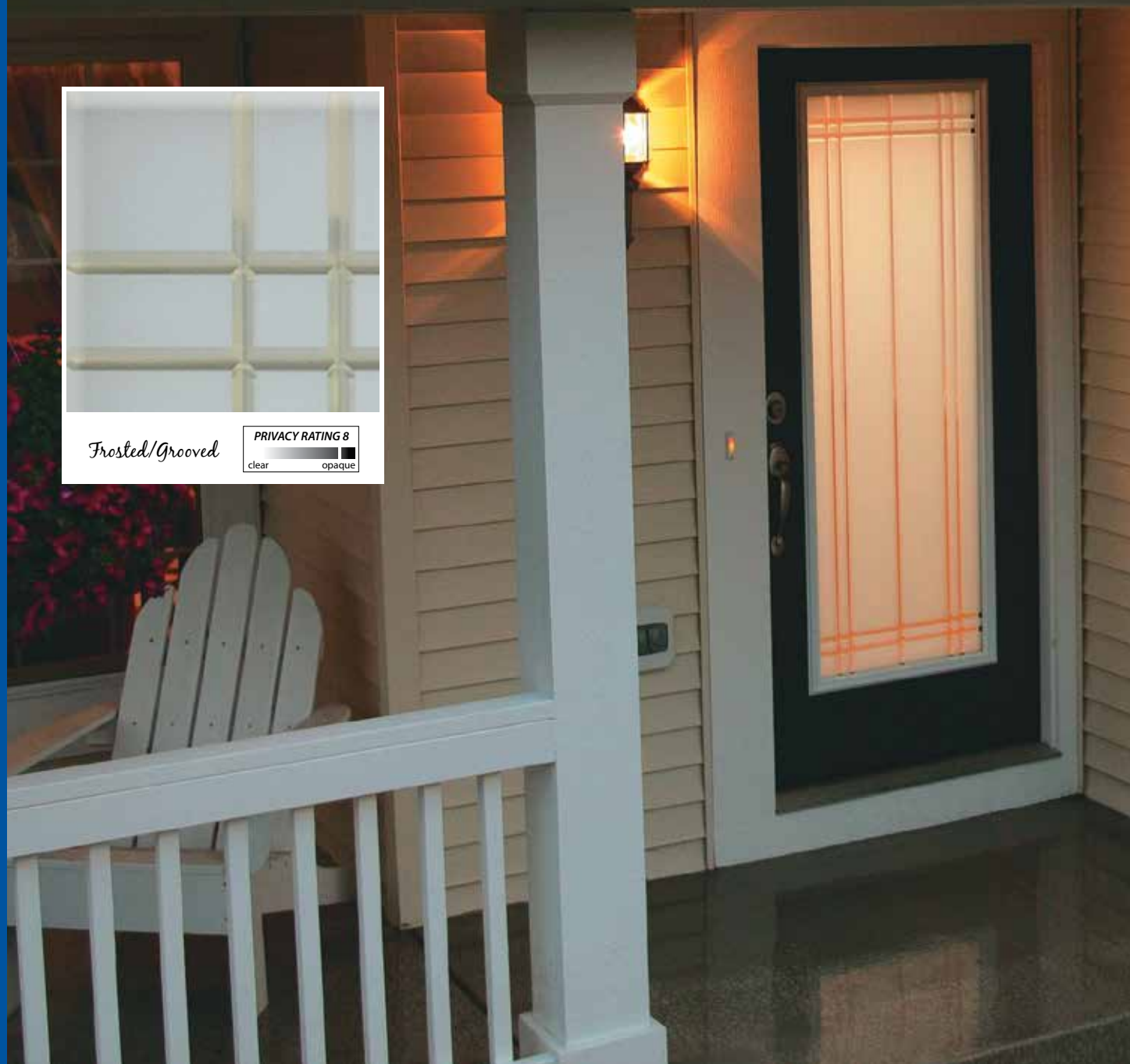

Frosted/Grooved

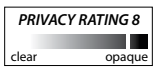

Opened position



Closed position

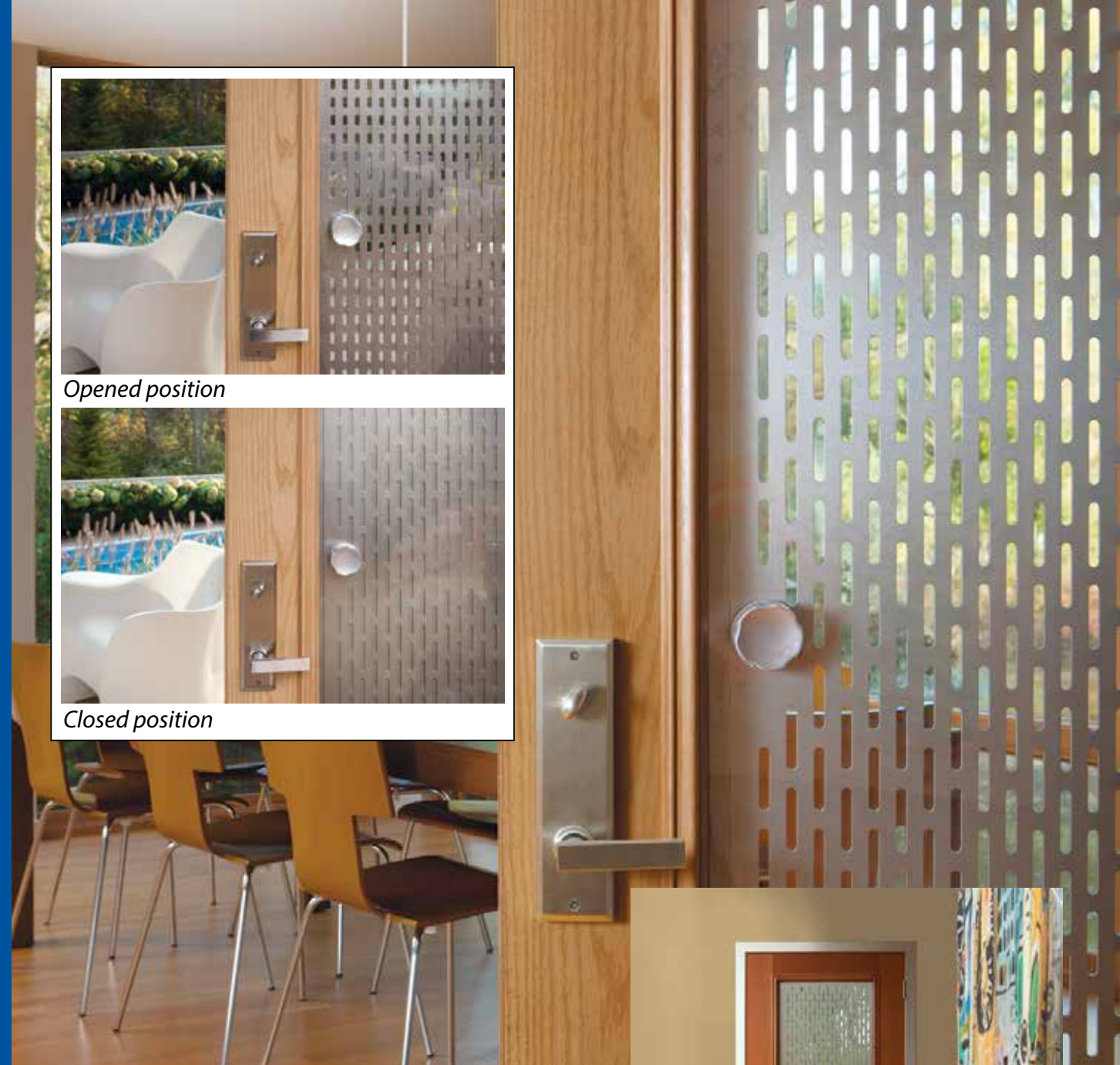

68 Simplicity Collection

Array Collection



SIM-230 (26 28 210 30)

SIM-230 (12" & 14")

SIM-430 (28 210 30)

SIM-4301P (28 30)

SIM-4301PC (28 30)

SIM-460 (28 210 30)

SIM-160 (12" & 14")

SIM-46080 (30 36)

SIM-16080 (12" & 14")



ARR-460 (28 210 30)

ARR-46080 (30 36)





6⁸ Standard Craftsman Collection

 Patina SF TF PRA-200 (30) PRA-260C (12" & 14") For Use With PRA-200 Only!	 Patina SF TF HAL-200 (30) HAL-160 (12" & 14")	 Zinc SF TF STE-200 (30) STE-160 (12" & 14")	 Oil-Rubbed Bronze SF TF GRE-200 (30) GRE-260C (12" & 14") For Use With GRE-200 Only!
 Patina SF TF GRA-200 (30) GRA-160 (12" & 14")	 Patina SF TF ART-200 (30) ART-160 (12" & 14")	 Patina SF TF TOP-200 (30) TOP-260C (12" & 14") For Use With TOP-200 Only!	 Clear & Obscure Etched Glass, NO Caming SF TF RIV-200 (30) RIV-160 (12" & 14") Clear & Obscure Etched Glass, NO Caming
 Patina/Beveled Clear I.G. SF TF FLT-200 (30) FLF-160 (12" & 14")	 Patina/Beveled Clear I.G. SF TF FLS-200 (30) FLF-160 (12" & 14")	 FLF-6312 / FLF-6613 (OPTIONAL) Craftsman C-21 Shelf (Available for Smooth or Textured Fiberglass 6/8 Standard Craftsman)	

6⁸ Standard Craftsman Collection

 Patina SF TF ADE-200 (30) ADE-160 (12" & 14")	 Patina SF TF NAT-200 (30) NAT-160 (12" & 14")	 Patina SF TF OAK-200 (30) OAK-260C (12" & 14") For Use With OAK-200 Only!	 Patina SF TF WAT-200 (30) WAT-160 (12" & 14")
--	--	---	--

6⁸ & 8⁰ Craftsman 4-Panel Collection

 Patina, Bevel Clear I.G. 6/8 SF TF FLF-64 (30) FLF-280 (12" & 14")	 Patina 6/8 SF TF WAT-64 (30) WAT-160 (12" & 14")
---	---

NO Door Shelf Available



6th Belleville Craftsman Collection

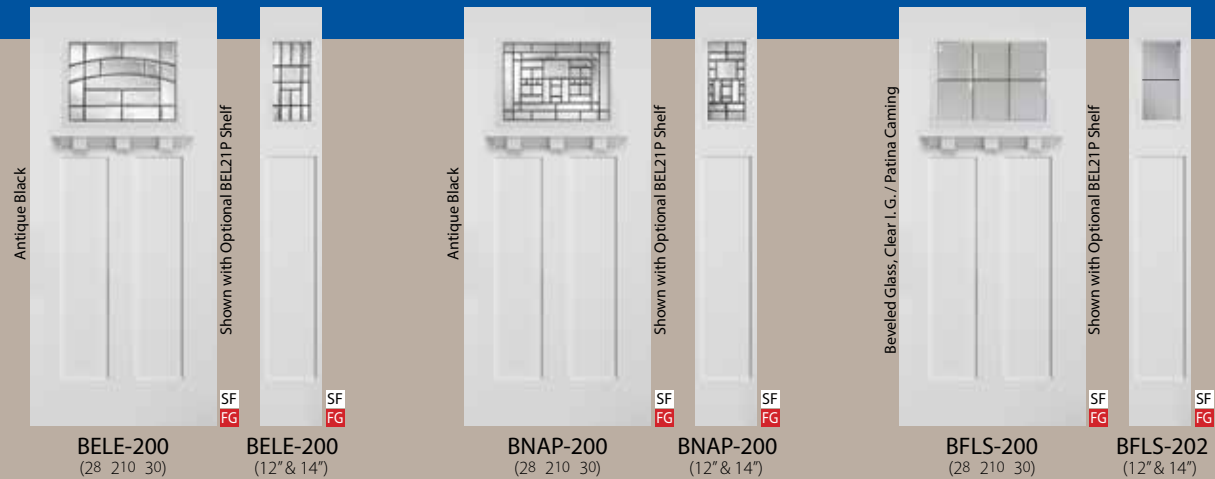

Antiqua Black

Shown with Optional BEL21P Shelf

Antiqua Black

Shown with Optional BEL21P Shelf

Beveled Glass, Clear I.G./Patina Caming

Shown with Optional BEL21P Shelf

6th Belleville Craftsman Collection



BEL-201 (28 210 30)

BEL101 (12" & 14")

BEL-203 (28 210 30)

BEL-101 (12" & 14")

BEL-206 (28 210 30)

BEL-102 (12" & 14")

Obscure Glass Options

The following obscure glass options are available with an extended leadtime.



Extended Leadtime Required.



Available with optional BEL21F shelf

NO Sidelite Shelf Available.

Belleville Craftsman

- Smooth & Fir-Grained Textured Fiberglass Doors
- Available In A Variety Of Glass Options As Shown
- Featuring Flush Mount Lite Kit Frames Which Are Reglazeable!

Choose One of 3 Factory-Applied Stains Specially Formulated For These Fir-Grain Doors & Sidelites

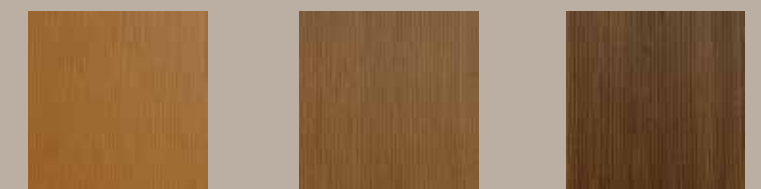

Ginger

Nutmeg

Clove

Color samples are reproduced as close as possible, actual color may vary. These stain colors are available for Belleville Fir Grain doors only!

Simulated Divided Lite



"Fir Grain"

6⁸ Flush-Glazed Craftsman Collection



FGFLT-200F (30) FGFLT-200F (14")



FGFLS-200F (30) FGFLS-202F (14")



FGMET-200F (30) FGMET-200F (14")

6⁸ Flush-Glazed Craftsman Collection



FGSPR-200F (30) FGSPR-200F (14")

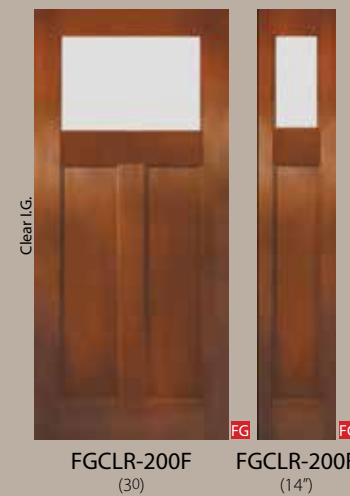

FGCLR-200F (30) FGCLR-200F (14")



FGCLR-202F (30) FGCLR-200F (14")



FGCLR-203F (30) FGCLR-200F (14")



FGCLR-204F (30) FGCLR-202F (14")



FGCLR-206F (30) FGCLR-202F (14")



NO Sidelite Shelf Option

Choose one of 3 factory-applied stains specially formulated for our Fir-Grain Flush-Glazed Craftsman doors & sidelites.



Caramel Toffee Chocolate

Color samples are reproduced as close as possible, actual color may vary. These stain colors are available for Fir-Grain Flush-Glazed Craftsman Collection ONLY!

*SDL: Simulated Divided Lite

NOTE: Glass options only as shown, these doors ARE NOT reglazeable!

Simulated Divided Lite



"Smooth Fiberglass"

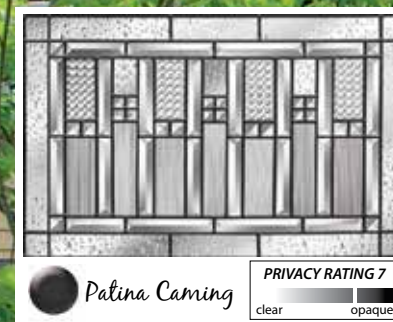

Patina Coming
PRIVACY RATING 7
clear opaque



"Vertical Grain Oak"

6⁸ Flush-Glazed Craftsman Collection



Optional Craftsman Shelf C-21 (No sidelite shelf option)

6⁸ Flush-Glazed Craftsman "Barrington"



Optional Craftsman Shelf

C-23 Craftsman Barrington Shelf
(For use on BAR-201 only.)



(No sidelite shelf option.)

Simulated Divided Lite



"Smooth Fiberglass"

8/0 Flush-Glazed Craftsman Collection



8/0 Flush-Glazed Craftsman Collection



Metropolis MET-300F 8/0 door.

Optional Craftsman Shelves





6⁸ Rustic Collection "Rustic Hardwood Grain"



RUS1PV
(30)



RUS2PV
(30)



Wrought Iron frame, Patina Caming

Chateau CHA-439W
(30)



RUS2PF
(30)



Wrought Iron frame, Patina Caming

Canterbury CAN-430W
(30)

6⁸ Rustic Sidelites



Canterbury CAN-160W
(12" & 14")



RUSL1
(12" & 14")



RUSL20
(12" & 14")

8⁰ Rustic Collection



RUS1PV80
(30)



RUS2PV80
(30, 36)



RUSL2080
(14")



Wrought Iron frame, Patina Caming

CHA-449W
(30)

Decorative Options for Rustic Doors

Clavos, hinge straps and speakeasies add an authentic touch to your Rustic door.

Straps & Clavos

Clavos

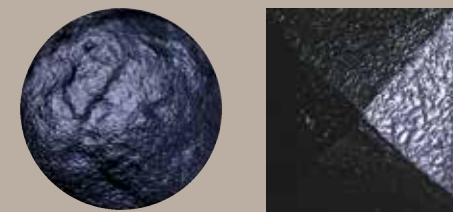

Codel offers clavos in 1-1/2" round or 1-1/2" square decorative black metal. The clavos are shipped loose so the customer can apply them on site in the design of their choice.



1-1/2" Clavos and 18" hinge straps can be added to Rustic doors.

Speakeasy

A Speakeasy adds a touch of old world charm. Codel offers a Seedy Reamy glass door Speakeasy as well as a solid one with a black door. Both seal tightly to prevent air infiltration.

(Size: 10" wide x 12" high.)



Seedy Reamy Glass Door
(Exterior View)



Seedy Reamy Glass Door
(Interior View)



Solid Black Door (no glass)
(Exterior View)



Solid Black Door
(Interior View)

Rockwell

MultiPoint - Grip Series

TONGUE LATCH SYSTEM



Consumer friendly with 1/4 turn deadbolt lock indicator.



Rockwell

MultiPoint - Lever Series

TRIPLE LATCH SYSTEM



(No Dummy Set Available)

Grip & Lever Series Features

- Available for 6/8, 7/0 and 8/0 Doors
- Available in Satin Nickel and Oil Rubbed Bronze
- Conventional Deadbolt and Lever Handle Spacing at 5-1/2"
- Adjustable Strike Plates
- Dummy Sets Available for Double Door Units
- Deadbolts & Levers Meet ANSI Grade 2 Standards
- Limited Lifetime Warranty

Only Available on Fiberglass Door Units

HOPPE

Handle of excellence.

MultiPoint Locking Systems

Codel Entry Systems offers Multi-Point Locking Systems of the finest design, most precise machining and highest quality materials providing homeowners with a secure locking system stronger than traditional deadbolt locks.



Screw Support

Prevents flexing or bending of the gear for lifetime performance and smoother operation.



Mishandling Device

Prevents multiple locking points from accidentally firing and potentially damaging door trim. Fully field reversible.



Solid Stainless Steel Deadbolt

Highly corrosion resistant and stronger than traditional deadbolts.



Manual Tongue (Top & Bottom)

While offering security in the locked position, the manual tongue engages into the jamb or mull post and retracts when opened, giving a smooth, clean appearance.



Flush Bolts (Top & Bottom)

(Optional) Multi-Point is available for the inactive door. The flush-bolts operate by the handle on the in-active panel, sending the flush-bolts simultaneously into the head and sill, offering a smooth and easy operation and securing your entry door.

Multi-Point Hardware Options & Finishes

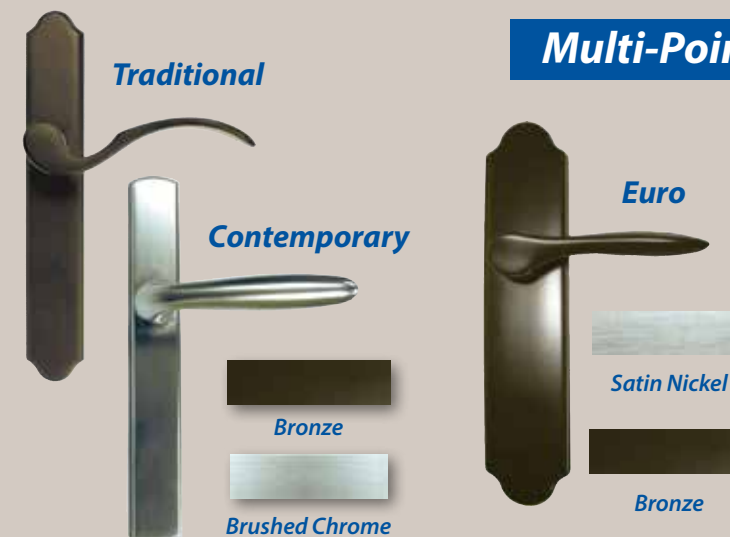

Features and Benefits

- 300 Series Stainless Steel-Highly corrosion resistant.
- Self Lubricating Parts - Last longer by eliminating the need to lubricate locks.
- Helps prevent doors from bowing and adds extra security at the same time.

- Only available on Fiberglass door units.
- Not available on cut-down units.

RETRACTABLE SCREENS



Hides simply, opens smoothly and closes securely.

**Standard & EZ-Fit Height Units in Stock.
Screen comes pre-installed on your
Codel prehung door and ready
to operate.**

**(7/0, 8/0 & Custom Height Screens Available
with Extended Leadtime.)**

Enjoy Fresh Air and the View

- For Inswing or Outswing units
- Provides a clear, unobstructed view
- Glides smoothly along tracks
- Easy operation and secure closure
- Latch and release handle
- In your choice of white or bronze



Available for double doors as well as singles.



Single door retractable screen.

RAISE & LOWER MINI BLINDS

Fully raise & lower blind with a light touch.



For sizes refer to pages 8, 10, 15 & 19.

No dusting. Blinds are sealed between tempered safety glass.

LIMITED
20
YEAR
WARRANTY



20MB Mini Blind.

DOORGUARD / JAMBGUARD / SILLGUARD



DOORGUARD was developed by Codel Entry Systems to protect both faces of the door slab during delivery, installation, and throughout the construction process.

The corrugated cardboard that is applied to each side of a Codel door slab protects the door from scratches, sheetrock and concrete mud, paint overspray and other jobsite debris. Applied with three heat treated plastic straps, DOORGUARD is very secure and does not affect the operation of the door, which can still be locked. Rain and humidity can deteriorate the cardboard and it does not protect the edges of the door from paint overspray. To combat these concerns, Codel has developed the next generation of DOORGUARD.

Once the DOORGUARD sheets are applied, the door enters a shrink wrap tunnel in which all six sides of the door slab are incased in clear plastic, ensuring added protection from the harsh Pacific Northwest climate. Installation recommendations are printed on the DOORGUARD.

The DOORGUARD package also includes SILLGUARD, JAMBGUARD, HINGEGUARD, and brickmould corner protectors.

JAMBGUARD is a steel reinforcement plate that is applied to the deadbolt area on the backside of the Codel door jamb. JAMBGUARD is standard on all single prehung units. The purpose of JAMBGUARD is to protect against intrusion by strengthening the weakest point of the door system. Unlike wraparound security plates, JAMBGUARD is concealed, accepting all types of lock hardware.



SILLGUARD is a durable plastic cover that is applied over the Codel door sill. The purpose of SILLGUARD is to eliminate job site debris from damaging the sill during the construction process. Once the project is complete, remove the SILLGUARD cover exposing a clean, defect free sill.

HINGE OPTIONS

Select a hinge that will match the finish of the hardware throughout the rest of your home. Codel offers a wide variety of hinge options, including; ball-bearing, solid brass, NRP and self-closing hinges.

Steel based hinges may develop rust if they are exposed to moisture. Codel recommends non-ferrous hinges on all outswing doors.



US15
Satin Nickel



US15A
Antique Nickel



US3-4
Brass



US10B
Bronze



US26
Bright Chrome



US26D
Brushed Chrome

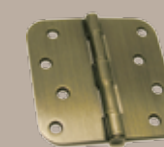

US5
Antique Brass



US1D
Black

SILLS

High Dam Sills

The Codel high dam sill features exclusive unibody construction and weather-tough materials to deliver maintenance-free reliability, even in the most moist and harsh climates.

Patio Door and Continuous Sidelite Systems feature a high dam barrier for critical weather-tight protection where the jambs meet the sill.



Precision engineered rail adjusts upward and downward for sealed tight protection. Counter beveled, two-piece, press fit screws easily adjust with a common #3 Phillips screwdriver.

Composite vinyl rail and nose retain "furniture" finish appearance in damp, inclement environments without showing signs of weathering, fading or staining.



Composite base.

"Safestep" aluminum surface meets architectural, residential and commercial requirements.

Sills available in the following finishes:



Mill Finish



Bronze Finish



Satin Nickel Finish

Thermally Broken Aluminum Astragal



- The aluminum astragal helps to protect doors from warping.
- The foam rubber boot at the bottom provides a better seal at the sill.
- The bottom boot, along with the "keeper" at the top, keeps doors from rattling.
- Steel & Smooth Fiberglass doubles will get a WHITE astragal - Textured Fiberglass doubles will get a BRONZE astragal.

Hardware bags available in three finishes: US3, US26D, US10B.

(Outswing pairs include an aluminum security cover.)

Outswing Bumper Sills

The bumper sill forms a dam making it difficult for wind and rain to leak into the home. Outswing bumper sills are recommended when your door will come in contact with wind & rain.



The tight fit of the door against the bumper sill helps prevent wind & rain from entering the home.

Jamsill Guard

Jamsill Guard is an adjustable sill pan flashing for exterior doors designed to help prevent water damage from door leaks. This product has been time tested for over 25 years. It is able to accommodate most door applications in either 2x4 or 2x6 construction and is not visible after installation.



IMPORTANT:
Failure to install a sill pan will void any warranty against leaking.

WeatherGuard

COMPOSITE FRAME



Codel WeatherGuard Composite Frame System is an innovative new alternative to traditional wood jambs. This poly-fiber doorframe system combines all the strength and convenience of wood with enhanced properties that make it moisture, rot and insect resistant. This unique formulation guarantees that the WeatherGuard frame will not absorb or wick moisture and will never warp, splinter or rot.

The WeatherGuard product line is available in two varieties. White Cap is a smooth, semi-gloss white that can be painted or left unfinished to compliment the Codel Smooth Fiberglass door. Textured has an embossed grain that can be painted or stained to compliment the Codel Textured Fiberglass door. The advanced WeatherGuard system can be installed the same way as traditional wood jambs.

NEW for WeatherGuard is our patent-pending “Seams-Rite” spline that enables the brick-mould to be applied to the jamb without using nails. Besides eliminating nail holes, “Seams-Rite” ensures a continuous water barrier. Also new, is an optional nailing flange.



WeatherGuard

COMPOSITE FRAME

Features & Benefits

- Poly-fiber composite jamb system is an attractive, affordable, and low maintenance option to traditional wood.
- Closed cellular structure is a unique formulation that ensures product will not warp, split or absorb moisture.
- Greater screw holding power than wood.
- Installs the same as traditional wood jambs.
- Available in smooth semi-gloss white cap and stainable textured embossed.
- Matching mullposts offering sidelite and transom capabilities.
- Installation and finishing recommendation label applied to every frame.
- Limited lifetime warranty.

CODEL

COATINGS

We Finish What We Start!



Stain Colors

Have any Codel textured fiberglass door stained your choice of 13 beautiful colors.



Medium Oak Light Oak Cinnamon Cedar



Red Cherry Mahogany Walnut

The stain colors shown above are available on ALL Standard Oak, Barrington & Rustic Grained Textured Fiberglass doors. (NOT available on Fir Grained doors.)



Ginger Nutmeg Clove

Available on Fir-Grain “Belleville Collection” Doors (See pages 15, 66 & 67)



Caramel Toffee Chocolate

Available on Fir-Grain “Flush-Glazed Craftsman” Doors (See pages 68 & 69)



Carbon Paint

Medium Oak

Artisan ART-430 door with ART-230 sidelite.

Paint or Stain, We've Got You Covered!

Paint Colors

Have any Codel smooth or textured fiberglass door painted your choice of 16 colors.



Cougar Tomato Hunter Jasper Carbon Iron Flint Navy
Pacific Khaki Olive Espresso Truffle Sand Bright Ivory

How come the color on my product doesn't look exactly like it does in the catalog or website?

Due to the limitations of photography, there is no guarantee that your product's colors will have the same appearance as they do in print or online. We always recommend you see an actual sample before deciding on a color choice. Contact a Codel dealer to request a color chip sample.

PREHUNG DOOR INSTALLATION



Wood & WeatherGuard Composite Frames

The proper installation and maintenance of a prehung door unit is absolutely critical to its performance and longevity. Without proper installation, a door unit will not fulfill its proper role in a home and can be a constant burden. Splashback from the patio deck is a major source of leakage and a prime cause of rot and water damage. Protect unit by immediately sealing all six sides of wood frame, raising unit above exterior deck level 6", providing a 24" (or greater) overhang, and by sloping the deck outward.

- The frame opening must be level, plumb and square.
- The sill must be level and provide support for the door.
- Install a sill pan or run a non-hardening caulk in 3 separate beads under the sill and along the bottom of the jamb legs.
- The unit should be installed in a closed position. Nail or screw temporarily, as position may need to be adjusted.
- There should be an 1/8" gap between the operating door and the header. Shim to achieve proper clearance.
- Place shims behind jamb leg at top, bottom and each hinge. Shim at same locations, behind strike jamb leg. Shim behind head jamb as needed.
- Nail or screw through shims into wall supports.
- Insulate all voids and caulk door unit on all exterior finish areas.
- Insulated glass will scratch easily. Clean carefully. Warranty does not cover scratches in glass due to cleaning.

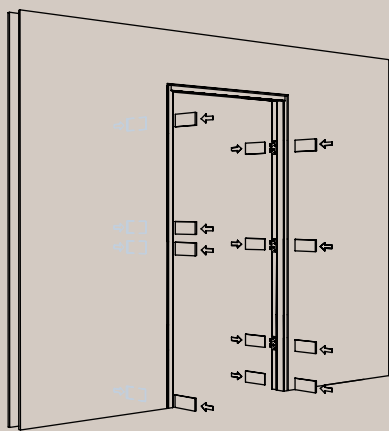

Shims must be placed behind the jamb at each hinge, latch and deadbolt location.

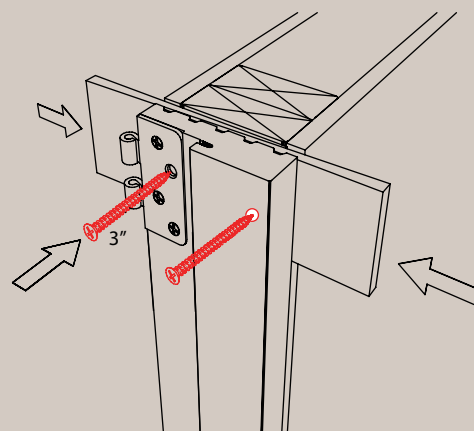

Wider jamb widths may require additional fasteners.

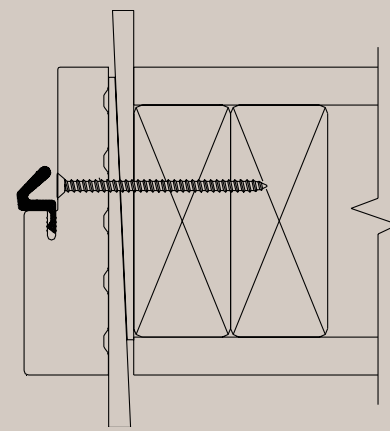

The screws that don't go through a hinge or strike plate can be hidden behind the weather-stripping.

***IMPORTANT! Failure to install a sill pan will void any warranty against leaking.**

FINISHING RECOMMENDATIONS

PAINT PREPARATION FOR ALL CODEL DOORS	Steel* Steel doors are primed.	Smooth Fiberglass* Smooth Fiberglass doors are unfinished white.	Textured Fiberglass* Textured Fiberglass doors are unfinished tan.
PREPARATION ■ Remove weatherstrip, door sweep, hinges and lock hardware. ■ All installation nail and screw holes should be filled with a quality painter's putty or caulking. ■ Apply a small bead of caulking between the jamb and brickmould. Allow to dry.	✓	✓	✓
CLEANING ■ Before applying a finish paint, clean the door with detergent and water or TSP or other water borne products. Wipe clean and dry. ■ Do not use industrial type fast dry solvent base materials, such as mineral spirits or lacquer thinner to clean door surfaces or a paint thinning agent as they may leave a residue on the door surface that is incompatible with latex coatings.	✓	✓	✓
SANDING ■ Scuff sand for better adhesion using 150-180 grit sandpaper prior to painting. Wipe door surface clean after sanding. Do not sand textured fiberglass doors.	✓	✓	N/A
ACRYLIC COATING SYSTEM (Steel Doors Only)			
PRIMING ■ The steel door has a factory applied waterbase prime coat.	N/A	N/A	N/A
TOP COAT ■ Apply one or two coats of acrylic emulsion latex paint.* ■ Do not use paints containing lacquer, linseed oil, or alkyd solvents.	✓	N/A	N/A
WATER BORNE COATING SYSTEMS (Smooth & Textured Fiberglass Doors Only)			
PRIMING ■ Use a high adhesion bonder/sealer type primer. For best results primer can be sanded with 3M Green paper 220 grit designed for use with latex coatings. (Do NOT sand textured fiberglass doors)	N/A	✓	✓
TOP COAT ■ Apply one or two coats of 100% acrylic latex enamel.*	N/A	✓	✓
OIL BASE COATING SYSTEMS (Smooth & Textured Fiberglass Doors Only)			
PRIMER ■ Use a high adhesion bonder/sealer type oil base primer.	N/A	✓	✓
TOP COAT ■ Apply one or two coats of alkyd oil enamel.	N/A	✓	✓
<ul style="list-style-type: none"> ■ Direct sunlight & extreme temperatures may cause: <ul style="list-style-type: none"> -Door to experience thermal bow. -Door glass moulding to expand/contract, exposing sealant, paint line, and cracking paint finish. ■ Doorglass moulding; apply a bead of quality caulking between frame & door after finish coat has cured or if door is left unfinished. ■ Primed & Hemlock jambs and brickmould must be finished prior to installation on face, both ends, and all edges. WeatherGuard frames do not require finishing. For finishing refer to label on jamb. 			

*If using latex paint it is important to follow the paint manufacturers min. temperature recommendations.

WeatherGuard Finishing Recommendations

Painting: White Cap & Textured Embossed Frame

Surface Preparation:

Wipe the frame thoroughly with appropriate water borne cleaner/degreaser for PVC type products to remove dirt, grease and other residue from the surface. Rinse the jamb off thoroughly and allow to dry completely before applying paint.

Coating:

Apply two coats of exterior enamel paint as per manufacturers technical data and label instructions for use with PVC type products. Kelly Moore DuraPoxy, Sherwin Williams SuperPaint A85 Series latex enamel and Parker Paint Speed Dri oil enamel are recommended by these manufacturers for use with the WeatherGuard frame without priming.

Notes:

- Lightly scuff sand.
- Do not use paint thinner or other petroleum distillates to clean the frame if a latex enamel topcoat is to be applied.
- Follow manufacturers instructions regarding dry time before re-coating.
- WeatherGuard Frames do not require painting to maintain the warranty.

STAINING: Textured Embossed Frame

It is recommended that a gel stain designed for fiberglass doors be used for this purpose. Follow the manufacturer's instructions on the can. (Gel stain can be found at your local paint store or home improvement center).

THE "CODEL" WAY - PREHUNG DETAILS

Inswing Adjustable Sill

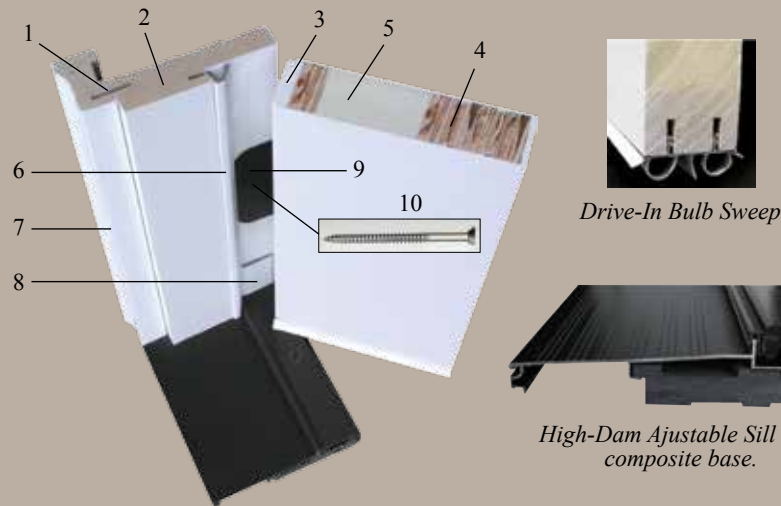

Drive-In Bulb Sweep

High-Dam Adjustable Sill with composite base.

Outswing Bumper Sill

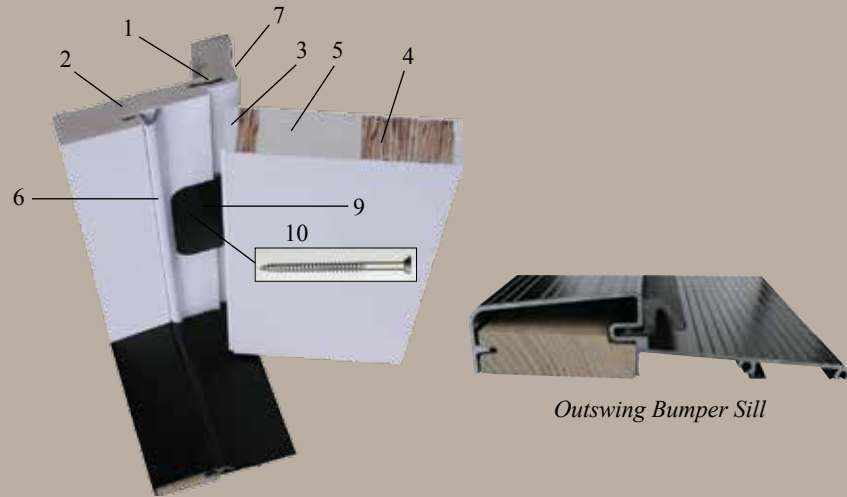

Outswing Bumper Sill

Inswing Low-Profile Sill

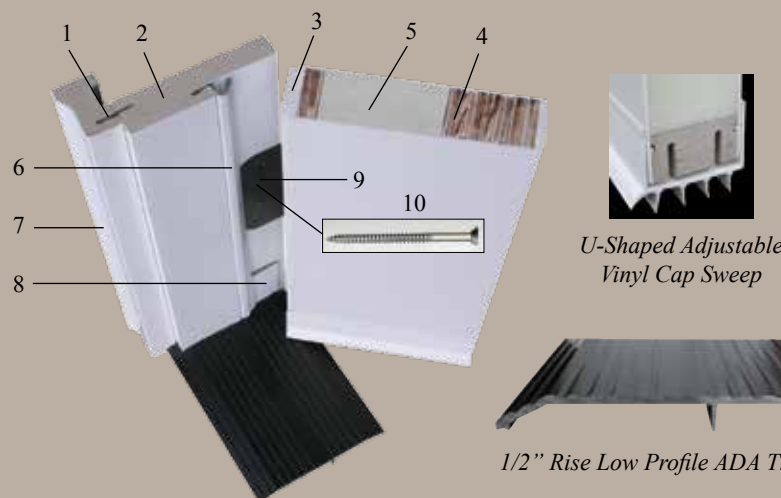

U-Shaped Adjustable Vinyl Cap Sweep

1/2" Rise Low Profile ADA Threshold

1. **"Seams-Rite"** - Spline attaching brickmould with NO nails. (Available on WeatherGuard Only)
2. **WeatherGuard Jamb** - Unique poly-fiber door frame system that will not absorb or wick moisture and will not warp, splinter or rot. (Optional)
3. **PVC Edge** - To protect against water.
4. **3-1/4" LVL Stile** - Continuous 3-1/4" lock rail extending the full length of the LOCK SIDE, keeping the door from bowing.
5. **R15.49 Panel Core** - High density poly-urethane core provides an energy efficient door free of CFCs.
6. **Q-Lon Weatherstripping** - Compression weatherstrip.
7. **WeatherGuard Brickmould** - All composite brickmould. (Optional)
8. **Corner Seal** - Extra protection against air & water infiltration.
9. **4" Hinge** - 5/8" radius steel based hinge available in a variety of colors to compliment any decor. (Codel recommends non-ferrous hinges on all outswing doors.)
10. **2-3/4" Installation Screw** - Secures the jamb into the wall stud. (Provided)

PREHUNG NET UNIT MEASUREMENTS

DOOR WIDTH	NET SLAB SIZE	NET UNIT WIDTHS				NET UNIT HEIGHTS			
		NET UNIT WIDTH	PLUS 1 EACH 12" SIDELITE	PLUS 2 EACH 12" SIDELITES	PLUS 1 EACH 14" SIDELITE	PLUS 2 EACH 14" SIDELITES	FIXED OR ADJ INSWING SILL	BUMPER OUTSWING SILL	ADA LOW-PRO IN/OUT SWING SILL
2-0 x 6-8	23-3/4" x 79"	25-1/2"	38-3/8"	51-1/4"	40-3/8"	55-1/4"	81-3/4"	80-1/2"	81"
2-4 x 6-8	27-3/4" x 79"	29-1/2"	42-3/8"	55-1/4"	44-3/8"	59-1/4"	81-3/4"	80-1/2"	81"
2-6 x 6-8	29-3/4" x 79"	31-1/2"	44-3/8"	57-1/4"	46-3/8"	61-1/4"	81-3/4"	80-1/2"	81"
2-6 x EZ FIT	28-1/4" x 76-3/4"	30"	N/A	N/A	N/A	N/A	79-1/2"	78-1/4"	78-3/4"
2-8 x 6-8	31-3/4" x 79"	33-1/2"	46-3/8"	59-1/4"	48-3/8"	63-1/4"	81-3/4"	80-1/2"	81"
2-10 x 6-8	33-3/4" x 79"	35-1/2"	48-3/8"	61-1/4"	50-3/8"	65-1/4"	81-3/4"	80-1/2"	81"
3-0 x 6-8	35-3/4" x 79"	37-1/2"	50-3/8"	63-1/4"	52-3/8"	67-1/4"	81-3/4"	80-1/2"	81"
3-0 x EZ FIT	34-1/4" x 76-3/4"	36"	N/A	N/A	N/A	N/A	79-1/2"	78-1/4"	78-3/4"
3-6 x 6-8	41-3/4" x 79"	43-1/2"	56-3/8"	69-1/4"	58-3/8"	73-1/4"	81-3/4"	80-1/2"	81"
4-0 x 6-8	47-3/4" x 79"	49-1/2"	62-3/8"	75-1/4"	64-3/8"	79-1/4"	81-3/4"	80-1/2"	81"
4-0 x 6-8 DBL	--	50"	62-7/8"	75-3/4"	64-7/8"	79-3/4"	81-3/4"	80-1/2"	81"
4-8 x 6-8 DBL	--	58"	70-7/8"	83-3/4"	72-7/8"	87-3/4"	81-3/4"	80-1/2"	81"
5-0 x 6-8 DBL	--	62"	74-7/8"	87-3/4"	76-7/8"	91-3/4"	81-3/4"	80-1/2"	81"
5-0 x EZ DBL	--	59"	N/A	N/A	N/A	N/A	79-1/2"	78-1/4"	78-3/4"
5-4 x 6-8 DBL	--	66"	78-7/8"	91-3/4"	80-7/8"	95-3/4"	81-3/4"	80-1/2"	81"
5-8 x 6-8 DBL	--	70"	82-7/8"	95-3/4"	84-7/8"	99-3/4"	81-3/4"	80-1/2"	81"
6-0 x 6-8 DBL	--	74"	86-7/8"	99-3/4"	88-7/8"	103-3/4"	81-3/4"	80-1/2"	81"
6-0 x EZ DBL	--	71"	N/A	N/A	N/A	N/A	79-1/2"	78-1/4"	78-3/4"
7-0 x 6-8 DBL	--	86"	98-7/8"	111-3/4"	100-7/8"	115-3/4"	81-3/4"	84-1/2"	81"
8-0 x 6-8 DBL	--	98"	110-7/8"	123-3/4"	112-7/8"	127-3/4"	81-3/4"	84-1/2"	81"
2-6 x 7-0	29-3/4" x 83"	31-1/2"	44-3/8"	57-1/4"	46-3/8"	61-1/4"	85-3/4"	84-1/2"	85"
2-8 x 7-0	31-3/4" x 83"	33-1/2"	46-3/8"	59-1/4"	48-3/8"	63-1/4"	85-3/4"	84-1/2"	85"
3-0 x 7-0	35-3/4" x 83"	37-1/2"	50-3/8"	63-1/4"	52-3/8"	67-1/4"	85-3/4"	84-1/2"	85"
5-0 x 7-0 DBL	--	62"	74-7/8"	87-3/4"	76-7/8"	91-3/4"	85-3/4"	84-1/2"	85"
5-4 x 7-0 DBL	--	66"	78-7/8"	91-3/4"	80-7/8"	95-3/4"	85-3/4"	84-1/2"	85"
6-0 x 7-0 DBL	--	74"	86-7/8"	99-3/4"	88-7/8"	103-3/4"	85-3/4"	84-1/2"	85"
2-6 x 8-0	29-3/4" x 95"	31-1/2"	44-7/8"	58-1/4"	46-7/8"	62-1/4"	97-3/4"	96-1/2"	97"
2-8 x 8-0	31-3/4" x 95"	33-1/2"	46-7/8"	60-1/4"	48-7/8"	64-1/4"	97-3/4"	96-1/2"	97"
3-0 x 8-0	35-3/4" x 95"	37-1/2"	50-7/8"	64-1/4"	52-7/8"	68-1/4"	97-3/4"	96-1/2"	97"
5-0 x 8-0 DBL	--	62"	75-3/8"	88-3/4"	77-3/8"	92-3/4"	97-3/4"	96-1/2"	97"
5-4 x 8-0 DBL	--	66"	79-3/8"	92-3/4"	81-3/8"	96-3/4"	97-3/4"	96-1/2"	97"
6-0 x 8-0 DBL	--	74"	87-3/8"	100-3/4"	89-3/8"	104-3/4"	97-3/4"	96-1/2"	97"
7-0 x 8-0 DBL	--	86"	99-3/8"	112-3/4"	101-3/8"	116-3/4"	97-3/4"	96-1/2"	97"

DECORATIVE TRANSOM SIZES & DOOR HANDING

DECORATIVE TRANSOM SIZES

SERIES	FOR USE OVER	ACTUAL GLASS SIZE	*NET UNIT SIZE
506	Use Over 3-0 Door w/2 Ea. 12" Sidelites	62-7/8" x 13-7/8"	64-1/2" x 96-3/4"
507	Use Over 3-0 Door w/2 Ea. 14" Sidelites	66-7/8" x 13-7/8"	68-1/2" x 96-3/4"
517	Use Over 3-0 Door (NO Sidelites)	35-7/8" x 11-7/8"	37-1/2" x 94-3/4"
521	Use Over 3-0 Door w/2 Ea. 12" Sidelites	62-7/8" x 11-7/8"	64-1/2" x 94-3/4"
532	Use Over 3-0 Door w/2 Ea. 12" Sidelites	62-7/8" x 13-3/4"	64-1/2" x 97-1/4"
578	Use Over 3-0 Door w/2 Ea. 12" Sidelites	62-5/8" x 11-3/4"	64-1/4" x 95-1/4"
602	Use Over 3-0 Door w/2 Ea. 12" Sidelites	61-3/4" x 13"	63-3/8" x 95-7/8"
603	Use Over 3-0 Door w/2 Ea. 14" Sidelites	65-3/4" x 13"	66-3/8" x 95-7/8"
6212	Use Over 3-0 Door w/2 Ea. 12" Sidelites	62-3/4" x 12"	64-3/8" x 94-7/8"
6312	Use Over 3-0 Door w/2 Ea. 12" Sidelites	63" x 12"	64-5/8" x 94-7/8"
6612	Use Over 3-0 Door w/2 Ea. 14" Sidelites	66-3/4" x 12"	68-3/8" x 94-7/8"
6613	Use Over 3-0 Door w/2 Ea. 14" Sidelites	66-1/2" x 13"	68-1/8" x 95-7/8"
7212	Use Over 6-0 DBL. Door (NO Sidelites)	72-1/4" x 12"	73-7/8" x 94-7/8"

*Net Unit Height includes a 6-8 INSWING prehung - For OUTSWING Unit, deduct 1-1/4"
For 7-0 prehung, add 4" to Net Unit Height
For 8-0 prehung, add 16" to Net Unit Height

DOOR SKIN TEXTURES (Unfinished)



Smooth Fiberglass



Textured Fiberglass



"White Oak"
Textured Fiberglass



"Rustic"
Textured Fiberglass



"Fir-Grain Craftsman"
Textured Fiberglass



"Fir Grain" Belleville
Textured Fiberglass



"Barrington" Craftsman
Textured Fiberglass



Steel

DOOR HANDING

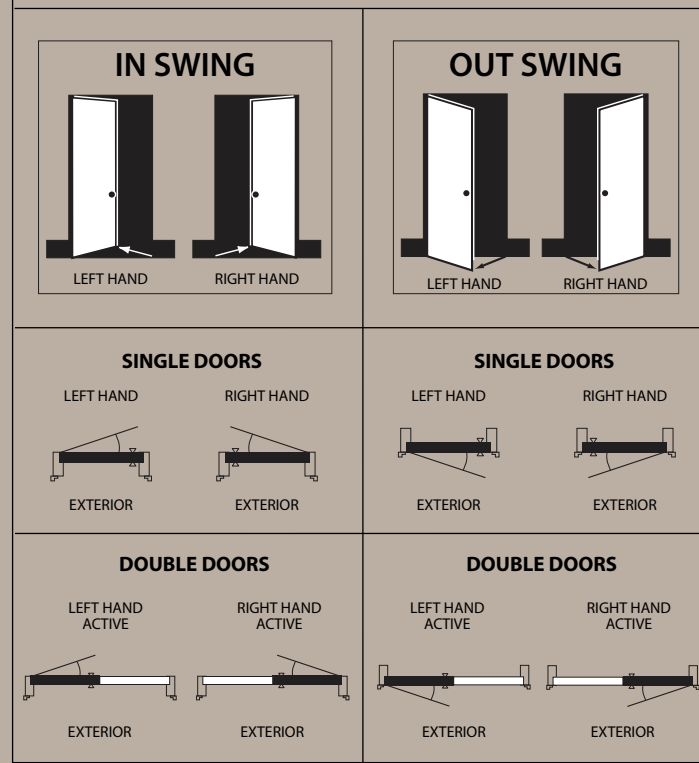

Index

A

Adelaide Collection 50-51
ADE-160 51
ADE-200 50
ADE-230 50, 51
ADE-240 51
ADE-430 50
ADE-440 50
ADE-460 50
ADE-4301P 50
ADE-4301PC 50
ADE-6212 51
ADE-6612 51
ADE-7212 51
ADE-16080 51
ADE-24080 50, 51
ADE-44080 50
ADE-46080 51
ADE-440801P 50

Array Collection 63
ARR-460 63
ARR-46080 63

Artisan Collection 40-41
ART-160 41
ART-200 40
ART-230 40, 41
ART-240 41
ART-280 41
ART-430 40
ART-440 40
ART-460 40
ART-480 41
ART-602/603 41
ART-4301P 40
ART-4301PC 40
ART-16080 41
ART-24080 41
ART-44080 41
ART-46080 41
ART-440801P 41

Astragal 81

B

Bastille 76
Belleville Collection (Fir Grain) 15
Belleville Craftsman 66-67
BEL-101 67
BEL-102 67
BEL-201 67
BEL-203 67
BEL-206 67
BELE-200 66
BFLS-200 66
BNAP-200 66

Brentwood Collection 38-39
BRE-160 39
BRE-200 38
BRE-230 38, 39
BRE-240 39
BRE-253 38
BRE-258 39
BRE-430 38
BRE-440 38

BRE-460 38
BRE-4301P 38
BRE-4301PC 38
BRE-16080 39
BRE-24080 39
BRE-25080 39
BRE-44080 39
BRE-46080 39
BRE-440801P 39

Bristol Collection 44-45
BRI-160 45
BRI-230 44, 45
BRI-240 45
BRI-280 45
BRI-430 44
BRI-440 44
BRI-460 44
BRI-480 45
BRI-506 45
BRI-4301P 44
BRI-4301PC 44
BRI-16080 45
BRI-24080 45
BRI-44060 45
BRI-46080 45
BRI-440801P 45

C

Camden Collection 46-47
CAM-16080 47
CAM-160 47
CAM-230 46, 47
CAM-240 47
CAM-430 46
CAM-440 46
CAM-949 46
CAM-4301P 46
CAM-4301PC 46
CAM-24080 46, 47
CAM-44080 47
CAM-440801P 47

Canterbury Collection 34-35
CAN-160 35
CAN-230 34, 35
CAN-240 35
CAN-430 34
CAN-440 34
CAN-460 34
CAN-949 34
CAN-4301P 34
CAN-4301PC 34
CAN-16080 35
CAN-24080 35
CAN44080 35
CAN-46080 35
CAN-440801P 35
CAN-TRW 35

Classique 76
Clavos 75
Codel Coatings 83

Contemporary Classic Doors 16
CON-865C 16
CON-865S 16
CON-2585 16
CON-7641C 16
CON-14641 16
CON-15153 16
CON-25153 16
CON-76415 16

Contemporary Hardware 77
Craftsman Collection 64-73

6/8 Belleville Craftsman Collection 66-67

6/8 Flush-Glaze Craftsman "Barrington" 71
BAR-101 71
BAR-201 71

6/8 Fir Grain Flush-Glazed Craftsman Collection 68-69
FGCLR-200F 69
FGCLR-202F 69
FGCLR-203F 69
FGCLR-204F 69
FGCLR-206F 69
FGFLS-200F 68
FGFLT-200F 68
FGMET-200F 68
FGSPR-200F 69

6/8 Smooth Fiberglass Flush-Glazed Craftsman Collection 70
SFCLR-200F 70
SFCLR-202F 70
SFCLR-203F 70
SFCLR-204F 70
SFCLR-206F 70

8/0 Flush-Glazed Craftsman Doors 72-73

CLR-300F 73
CLR-302F 73
CLR-303F 73
CLR-304F 73
CLR-306F 73
FLS-300F 72
FLS-302F 72
MET-300F 72
MET-301F 72
SPR-300F 72

6/8 Standard Craftsman Collection 64-65

ADE-160 64
ADE-200 64
ART-160 65
ART-200 65
FLF-64 65
FLF-160 65
FLF-280 65
FLF-6480 65
FLS-200 65
FLT-200 65
GRA-160 65
GRA-200 65
GRE-200 65
GRE-260C 65
HAL-160 65
HAL-200 65
NAT-160 64
NAT-200 64
OAK-200 64
OAK-260C 64
PRA-200 65
PRA-260C 65
RIV-160 65
RIV-200 65
STE-160 65
STE-200 65
TOP-200 65
TOP-260C 65

Entropy Collection 22
ENT-160 22
ENT-280 22
ENT-460 22
ENT-480 22
ENT-16080 22
ENT-46080 22

Euro Hardware 77
EZ-Fit Double Doors Net Unit Sizes 12

F

Fast Frame 90-Minute 20-21
Finishing Recommendations 85

Fir Grain Belleville Collection Doors 15

WAT-64 65
WAT-160 64
WAT-200 64

D

Decorative Collection 22-63
Adelaide 50-51
Array 63
Artisan 40-41
Brentwood 38-39
Bristol 44-45
Camden 46-47
Canterbury 34-35
Eloquence 54-55
Entropy 22
Grace 52-53
Greenfield 26-27
Impressions 30-31
Inspire 58-59
Jacinto 23
Legacy Master 28-29
Natalia 24-25
Nouveau 60-61
Oak Park 32-33
Prairie Bevel 42-43
Simplicity 62
Sonora 56-57
Topaz 48-49
Waterton 36-37

Decorative Transom Sizes 88
Distinct Features 4
Door Difference 5
DoorGuard 80
Door Handing 88
Door Skin Textures 88
Double Door Handing 12

E

Eloquence Collection 54-55
ELO-160 55
ELO-230 54, 55
ELO-240 55
ELO-400 54
ELO-430 54
ELO-440 54
ELO-460 54
ELO-4301P 54
ELO-4301PC 54
ELO-16080 55
ELO-24080 55
ELO-44080 55
ELO-46080 55
ELO-440801P 55

FG6P 15
 FG9 15
 FG10GBG 15
 FG15GBG 15
 FG20 15
 FG20MB 15
 FG29 15
 FG61 15
 FG61MB 15
 FG69GBG 15
 FGSL1 15
 FGSL1MB 15
 FGSL3GBG 15
 FGSL5GBG 15
 FGSL20 15
 FGSL20MB 15

Flush-Glazed Profile vs. Standard Lite Kit Profile 11

G

Grace Collection 52-53
 GRC-230 52
 GRC-400 52
 GRC-430 52
 GRC-648 52
 GRC-4301P 52
 GRC-4301PC 52
 GRC-160 53
 GRC-230 53
 GRC-240 53
 GRC-280 53
 GRC-440 53
 GRC-460 53
 GRC-480 53
 GRC-919 53
 GRC-949 53
 GRC-16080 53
 GRC-24080 53
 GRC-44080 53
 GRC-46080 53
 GRC-440801P 53

Greenfield Collection 26-27
 GRE-160 26
 GRE-200 26
 GRE-240 26
 GRE-260C 26
 GRE-280 27
 GRE-440 26
 GRE-460 26
 GRE-480 27
 GRE-521 27
 GRE-16080 27
 GRE-24080 27
 GRE-44080 27
 GRE-46080 27
 GRE-440801P 27

H

Hinge Options 80
 Hinges
 US1D Black 80
 US3-4 Brass 80
 US5 Antique Brass 80
 US10B 80
 US15A Antique Nickel 80
 US15 Satin Nickel 80
 US26 Bright Chrome 80
 US26D Brushed Chrome 80
 Hoppe Multipoint 77

I

Impressions Collection 30-31
 IMP-160 31
 IMP-230 30, 31
 IMP-280 31
 IMP-400 30
 IMP-430 30
 IMP-460 30
 IMP-480 31
 IMP-507 31
 IMP-949 30
 IMP-4301P 30
 IMP-4301PC 30
 IMP-16080 31
 IMP-46080 31

Inspire Collection 58-59
 INS-230 58, 59
 INS-240 59
 INS-400 58
 INS-430 58
 INS-440 58
 INS-4301P 58
 INS-4301PC 58
 INS-24080 59
 INS-44080 59
 INS-440801P 59

J

Jacinto Collection 23
 JAC-160 23
 JAC-460 23
 JAC-507 23
 JAC-521 23
 JAC-532 23
 JAC-16080 23
 JAC-46080 23

JambGuard 4, 80
 Jamsill Guard 81

L

Legacy Master Collection 28-29
 LEG-160 29
 LEG-230 28, 29
 LEG-240 29
 LEG-280 29
 LEG-430 28
 LEG-440 28
 LEG-460 28
 LEG-480 29
 LEG-506/507 29
 LEG-517 29
 LEG-949 28
 LEG-4301P 28
 LEG-4301PC 28
 LEG-16080 29
 LEG-24080 29
 LEG-44080 29
 LEG-46080 29
 LEG-440801P 29

M

Mini Blinds 79
 MultiPoint Locking Systems 76–77
 Hoppe 77
 Rockwell 76

N

Natalia Collection 24-25

NAT-160 24
 NAT-200 24
 NAT-240 24
 NAT-440 24
 NAT-460 24
 NAT16080 25
 NAT-24080 25
 NAT-44080 25
 NAT-46080 25
 NAT-440801P 25

Ninety Minute Fire Doors 20-21
 C490 21
 C690 21
 CF90 21

Nouveau Collection 60-61

NOU-110 61
 NOU-160 61
 NOU-230 60, 61
 NOU-240 61
 NOU-400 60
 NOU-430 60
 NOU-440 61
 NOU-460 61
 NOU-507 61
 NOU-521 61
 NOU-578 61
 NOU-648 60
 NOU-919 61
 NOU-949 61
 NOU-4301P 60
 NOU-4301PC 60
 NOU-16080 61
 NOU-24080 61
 NOU-44080 61
 NOU-46080 61
 NOU-440801P 61

O

Oak Park Collection 32-33
 OAK-160 33
 OAK-200 32
 OAK-230 32, 33
 OAK-240 33
 OAK-260C 33
 OAK-430 32
 OAK-440 32
 OAK-460 32
 OAK-480 33
 OAK-4301P 32
 OAK-4301PC 32
 OAK-24080 33
 OAK-44080 33
 OAK-46080 33
 OAK-440801P 33

Obscure Glass

Clear 17
 Narrow Reed Horizontal 17
 Narrow Reed Vertical 17
 Rain 17
 Rooftop 17
 Sable 17
 Satin Etch 17
 Seedy Reamy 17
 White Laminate 17
 Outswing Bumper Sills 81

P

Prairie Bevel Collection 42-43
 PRA-160 43

PRA-200 42
 PRA-230 42, 43
 PRA-240 43
 PRA-260C 43
 PRA-430 42
 PRA-440 42
 PRA-460 42
 PRA-4301P 42
 PRA-4301PC 42
 PRA-16080 43
 PRA-24080 43
 PRA-44080 43
 PRA-46080 43
 PRA-440801P 43

Prehung Details - The “Codel” Way 86
 Prehung Net Unit Measurements 87

R

Raise/Lower MiniBlinds 79
 Retractable Screens 78
 Phantom 78
 Rockwell 76
 Rockwell Multipoint 76
 Rustic Collection 74–75
 Clavos 75
 Speakeasy 75
 Straps 75

Rustic Doors 74-75

CAN-160W 75
 CAN-430W 74
 CHA-439W 74
 CHA-449W 75
 RUS1PV 74
 RUS1PV80 75
 RUS2PF 74
 RUS2PV 74
 RUS2PV80 75
 RUSSL1 75
 RUSSL20 75
 RUSSL2080 75

S

Savoy 76
 SillGuard 80
 Sills 81
 High Dam Sills 81
 Sill Finishes 81

Simplicity Collection 62

SIM-160 62
 SIM-230 62
 SIM-430 62
 SIM-460 62
 SIM-4301P 62
 SIM-4301PC 62
 SIM-16080 62
 SIM-46080 62

Smooth Fiberglass Collection 6-8

SF1 7
 SF2P 7
 SF2PC 7
 SF3GBG 8
 SF3P 7
 SF4P 6
 SF4P20 6
 SF6GBG 8
 SF6P 6
 SF6P20 6
 SF6V 7

SF6V1P 6
 SF6V1PC 7
 SF9 8
 SF9P 6
 SF10 8
 SF15 8
 SF20 8
 SF20MB 8
 SF29 6
 SF44 7
 SF61 6
 SF61MB 8
 SF61MB1P 8
 SF61MB1PC 8
 SF62 6
 SF64 7
 SF64C 7
 SF64GBG 7
 SF66 7
 SF66CL 8
 SF69 7
 SF81 7
 SF91 8
 SF93 6
 SF291P 7
 SF291PC 7
 SF611P 7
 SF611PC 6
 SF622 6
 SF648CL 8
 SF691P 6
 SF691PC 7
 SF919CL 7
 SFC 7
 SFF 6
 SFSL1 8
 SFSL1MB 8
 SFSL3 8
 SFSL5 8
 SFSL8 8
 SFSL20 8
 SFSL20MB 8
 SFW 7

Smooth Fiberglass EZ-Fit “Retro Sized” Double Doors 12

SF9FEZ 12
 SF10FEZ 12
 SF20FEZ 12
 SF20MBEZ 12
 Smooth Fiberglass EZ-Fit “Retro Sized” Swinging Patio 13
 SF9FEZP 13
 SF10FEZP 13
 SF20FEZP 13
 SF20MBEZP 13

Smooth Fiberglass Flush-Glazed Doors 11

SF3F80 11
 SF9F 11
 SF9F70 11
 SF10F 11
 SF10F70 11
 SF12F80 11
 SF20F 11
 SF20F70 11
 SF20F80 11
 SF20FMB 11
 SF20FMB70 11
 SF29F 11
 SF61F 11
 SF69F 11

SFSL1F 11
 SFSL20F 11
 Smooth Fiberglass New Construction Swinging Patio
 SF9FNCP 13
 SF10FNCP 13
 SF20FNCP 13
 SF20MBNCP 13

Smooth & Textured Contemporary Classics Collection 16

Smooth & Textured EZ-Fit “Retro Sized” Double Doors 12

Smooth & Textured EZ-Fit “Retro Sized” Swinging Patio 13

Smooth & Textured Flush-Glazed Fiberglass Doors 11

Smooth & Textured New Construction Swinging Patio 14

Sonora Collection 56-57

SON-160 57
 SON-230 56, 57
 SON-240 57
 SON-430 56
 SON-440 56
 SON-460 56
 SON-4301P 56
 SON-4301PC 56
 SON-16080 57
 SON-24080 57
 SON-44080 57
 SON-46080 57
 SON-440801P 57

Speakeasy 75

Steel Door Collection 18-19

C3P 19
 C4P 19
 C6P 19
 C6V 19
 C16 19
 C29 19
 C61 19
 C61MB 19
 C62 19
 C64 19
 C69 19
 C81 19
 C622 19
 C836 19
 C648CL 19
 C919CL 19
 CF 19
 CF1 19
 CF9 19
 CF10 19
 CF15 19
 CF16 19
 CF20 19
 CF20MB 19
 CSL1 19
 CSL1MB 19
 CSL2 19
 CSL3 19
 CSL5 19
 CSL20 19
 CSL20MB 19
 CW 19
 CWC 19

Straps 75

T

Testing Results 5

Textured Fiberglass Collection 9-10

TF1 10
 TF3GBG 10
 TF3P 9
 TF4P 9
 TF6GBG 10
 TF6P 9
 TF6P20 9
 TF6V 10
 TF9 10
 TF9P 9
 TF10 10
 TF15 10
 TF20 10
 TF20MB 10
 TF29 10
 TF44 9
 TF61 10
 TF61MB 10
 TF62 9
 TF64 9
 TF64C 9
 TF64GBG 9
 TF66 9
 TF66CL 10
 TF69 10
 TF81 10
 TF91 10
 TF93 9
 TF622 10
 TF648CL 10
 TFC 10
 TFF 9
 TFSL1 10
 TFSL1MB 10
 TFSL3 10
 TFSL5 10
 TFSL8 10
 TFSL20 10
 TFSL20MB 10
 TFW 10

Textured Fiberglass EZ-Fit “Retro Sized” Double Doors

TF9FEZ 12
 TF10FEZ 12
 TF20FEZ 12
 TF20MBEZ 12
 Textured Fiberglass EZ-Fit “Retro Sized” Swinging Patio
 TF9FEZP 13
 TF10FEZP 13
 TF20FEZP 13
 TF20MBEZP 13
 Textured Fiberglass Flush-Glazed Doors 11
 TF3F 11
 TF9F 11
 TF10F 11
 TF12F80 11
 TF20F 11
 TF20F80 11
 TF20FMB 11
 TF29F 11
 TF61F 11
 TF69F 11
 TFSL1F 11

Textured Fiberglass New Construction

Swinging Patio 14
 TF9FNCP 14
 TF10FNCP 14
 TF20FNCP 14
 TF20MBNCP 14

Thermally Broken Aluminum Astragal 81

Topaz Collection 48-49

TOP-160 49
 TOP-200 48
 TOP-230 48, 49
 TOP-240 49
 TOP-260C 49
 TOP-430 48
 TOP-440 48
 TOP-460 48
 TOP-4301P 48
 TOP-4301PC 48
 TOP-16080 49
 TOP-24080 49
 TOP-44080 49
 TOP-46080 49
 TOP-440801P 49

Traditional Hardware 77

V

Vantage 76

W

Waterton Collection 36-37

WAT-64 36
 WAT-160 37
 WAT-200 36
 WAT-230 36, 37
 WAT-240 37
 WAT-280 37
 WAT-430 36
 WAT-440 36
 WAT-460 36
 WAT-480 37
 WAT-4301P 36
 WAT-4301PC 36
 WAT-16080 37
 WAT-24080 37
 WAT-44080 37
 WAT-46080 37
 WAT-440801P 37
 WAT-TRW 37

WeatherGuard 82

Nailing Flange 82
 “Seams-Rite” Spline 82
 Windsor 76



CODEL COATINGS

We Finish What We Start!

Stain Colors

Have any Codel textured fiberglass door stained your choice of 13 beautiful colors.



Medium Oak Light Oak Cinnamon Cedar

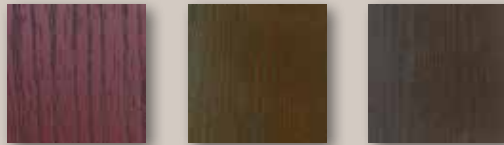

Red Cherry Mahogany Walnut

The stain colors shown above are available on ALL Oak, Barrington & Rustic Grained Textured Fiberglass doors. (NOT available on Fir Grained doors.)



Ginger Nutmeg Clove

Available on Fir-Grain "Belleville Collection" Doors (See pages 15, 66 & 67)

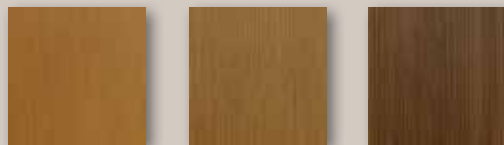

Caramel Toffee Chocolate

Available on Fir-Grain "Flush-Glazed Craftsman" Doors (See pages 68 & 69)



Artisan ART-430 door with ART-230 sidelite.

Paint or Stain, We've Got You Covered!

Paint Colors

Have any Codel smooth or textured fiberglass door painted your choice of 16 colors.



Cougar Tomato Hunter Jasper Carbon Iron Flint Navy



Pacific Khaki Olive Espresso Truffle Sand Bright Ivory

How come the color on my product doesn't look exactly like it does in the catalog or website?

Due to the limitations of photography, there is no guarantee that your product's colors will have the same appearance as they do in print or online. We always recommend you see an actual sample before deciding on a color choice. Contact a Codel dealer to request a color chip sample.